

**Thermocouple Scanner, Four Channel
with CAN, SAE J1939**

USER MANUAL

P/N: AXTC4

VERSION HISTORY

Version	Date	Author	Modifications
1.0.0	January 24, 2007	Anna Murray	Initial Draft
1.0.1	August 17, 2007	Anna Murray	Changed name to AXTC4 Fixed Defaults for Temperature SPNs in Section 3.1
1.1.0	December 19, 2007	Anna Murray	Updated Diagnostic section to reflect that DM1 will be sent every 1 second whether or not there are any active DTCs
1.2.0	July 15, 2008	Anna Murray	Added support for T-type thermocouples
2.0.0	June 21, 2010	Anna Murray	Updated Footer on cover page Added extra text in the description section 1.1 Updated SPN List per J1939-71, JAN 2009 Added "User Defined" capability for SPNs
--	June 21, 2010	A. Wilkins	Added Technical Specifications
2.0.1	March 25, 2015	Amanda Wilkins	Updated power supply input to 12V or 24Vdc
-	July 29, 2015	Amanda Wilkins	Added vibration compliance
2.0.2	August 30, 2023	Kiril Mojsov	Performed Legacy Updates

ACCRONYMS

ACK	Positive Acknowledgement
DM	Diagnostic Message (from SAE J1939 standard)
DTC	Diagnostic Trouble Code
EA	The Axiomatic Electronic Assistant (A Service Tool for Axiomatic ECUs)
ECU	Electronic Control Unit (from SAE J1939 standard)
NAK	Negative Acknowledgement
PDU1	A format for messages that are to be sent to a destination address, either specific or global
PDU2	A format used to send information that has been labeled using the Group Extension technique, and does not contain a destination address.
PGN	Parameter Group Number (from SAE J1939 standard)
SPN	Suspect Parameter Number (from SAE J1939 standard)
TC	Thermocouple

TABLE OF CONTENTS

1. GENERAL	4
1.1. Description of Thermocouple Scanner	4
1.2. Introduction to SAE J1939 Features	5
1.3. Sending Single Frame Messages	6
1.4. Dimensions and Pinout	7
2. DIAGNOSTIC MESSAGES	8
2.1. Supported FMI's	8
2.2. Diagnostic Log	9
2.3. Clearing Active DTCs	9
3. ECU SETPOINTS	10
3.1. Thermocouple Setpoints	10
3.2. Miscellaneous Setpoints	15
4. USING ECU WITH AXIOMATIC ELECTRONIC ASSISTANT	17
4.1. Installing the Axiomatic EA	17
4.2. Screen Captures	17
Appendix A - TECHNICAL SPECIFICATIONS	20

References

J1939	Recommended Practice for a Serial Control and Communications Vehicle Network, SAE, October 2007
J1939/21	Data Link Layer, SAE, December 2006
J1939/71	Vehicle Application Layer, SAE, January 2009
J1939/73	Application Layer-Diagnostics, SAE, February 2010
J1939/81	Network Management, SAE, March 2017
TDAXTC4	Technical Datasheet, Thermocouple Module, 4 Channel, Axiomatic Technologies 2016
UMAX07050X	User Manual, Axiomatic Electronic Assistant and USB-CAN, Axiomatic Technologies, 2006-2023

1. GENERAL

1.1. Description of Thermocouple Scanner

There are four channels on the TC4, each with three pins at the connector for +ve, -ve and shield connections. All channels are fully isolated from each other, the CAN lines, and from the power supply. All channels are sampled simultaneously at a rate of 5 scans/second (200ms update rate).

Temperature is measured in °C, with up to a 0.001°C resolution. Each channel can be individually configured to measure J, K or T type thermocouples. When installed properly, the scanner will send temperatures with +/- 1°C accuracy.

A very precise analog-to-digital converter, with a programmable gain, measures the thermocouple input voltage. As the voltage changes, the controller will adjust the gain accordingly to get the best resolution and accuracy of the signal. For rapid changes at the input, such as an open-circuit, it may take a couple of scans before the appropriate range is found. Since there are 8 possible gains, an open-circuit (measured using the lowest gain) can take up to 1.6 seconds to be flagged, if the last 'good' input was in the highest gain range.

Another feature of the ADC is that it has a programmable rejection mode for either 50Hz or 60Hz. It provides better than 110dB normal mode rejection of the line frequency and all its harmonics.

If desired, the average temperature of all the active channels can be broadcasted to the network using the default "Engine Average Information" PGN, or on a Proprietary B message. This feature is described in detail in section 3.2.

The AXTC4 supports all the temperature SPNs as defined in J1939-71 as of January 2009. In order to allow for future expansion, the user can select a "User Defined" SPN (0) which enables a variety of setpoints associated with transmitting the data on the network. This allows the user to select the PGN, size (1 or 2 bytes), data index and repetition rate of the message that will broadcast the temperature for the selected channel. More information about this feature can be found in Sections 1.3 and 3.1.

On power-up, the AXTC4 will immediately send its NAME to the network. However, in order to prevent erroneous readings before the data from all channels have been read correctly, the unit will only start broadcasting either temperature or diagnostic data after 5 seconds have elapsed.

1.2. Introduction to SAE J1939 Features

The software was designed to provide flexibility to the user with respect to messages sent from the TC4 by providing:

- Configurable ECU Instance in the NAME (to allow multiple ECUs on the same network)
- Easily selectable SPN from a drop list of the temperature SPNs supported by the standard.
- Configurable Diagnostic Messaging Parameters
- Diagnostic Log, maintained in non-volatile memory

This document assumes the reader is familiar with the SAE J1939 standard. Terminology from the standard is used, but is not described in this document.

The ECU is compliant with the standard SAE J1939, and supports the following PGNs from the standard.

From J1939-21 - Data Link Layer

- Request 59904 (\$00EA00)
- Acknowledgment 59392 (\$00E800)
- Transport Protocol – Connection Management 60416 (\$00EC00)
- Transport Protocol – Data Transfer Message 60160 (\$00EB00)
- Proprietary B, available messages 65281 (\$00FF01)
to 65535 (\$00FFFF)

From J1939-73 - Diagnostics

- DM1 - Active Diagnostic Trouble Codes 65226 (\$00FECA)
- DM2 – Previously Active Diagnostic Trouble Codes 65227 (\$00FECB)
- DM3 - Diagnostic Data Clear/Reset for Previously Active DTCs 65228 (\$00FECC)
- DM11 - Diagnostic Data Clear/Reset for Active DTCs 65235 (\$00FED3)
- DM14 – Memory Access Request 55552 (\$00D900)
- DM15 – Memory Access Response 55296 (\$00D800)
- DM16 – Binary Data Transfer 55040 (\$00D700)

From J1939-81 - Network Management

- Address Claimed/Cannot Claim 60928 (\$00EE00)
- Commanded Address 65240 (\$00FED8)

From J1939-71 – Vehicle Application Layer

- All of the temperature SPNs from this section, and their corresponding PGNs. See section 3.1 for more information.

1.3. Sending Single Frame Messages

Each SPN that is supported by the TC4 has a predefined size (1 or 2 bytes) and consequently resolution and offset, associated with it.

One-byte parameters have a resolution of 1°C/bit and an offset of -40°C, resulting in a measurable range of -40°C to 210°C. Temperatures outside of that range are sent as either the minimum or maximum value allowable. If an open-circuit is detected on that channel, the data will be sent as 254 (0xFE), the error indicator value.

Two-byte parameters have a resolution of 0.03125°C/bit and an offset of -273°C, resulting in a measurable range of -273°C to 1735°C. Temperatures outside of that range are sent as either the minimum or maximum value allowable. If an open-circuit is detected on that channel, the data will be sent as 65279 (0xFEFF), an error indicator value.

The SPN drop list includes all temperature SPNs from the J1939-71 standard published up to January of 2009. If an SPN is not supported by the drop list, the user can select a zero SPN, which then allows them to define the SPN and PGN per the application requirements.

The Parameter Group Number (PGN) that will be used to send a temperature to the J1939 network will be entirely dependant on the Suspect Parameter Number (SPN) that was selected for that channel. In all cases, the PGN is a PDU2 type. Each PGN has a predefined priority and repetition rate associate with it.

Regardless of the SPN selected, the temperature is always available on request for the associated PGN.

All single-frame messages sent from the TC4 will be sent as 8-bytes. Unused bytes within the PGN are stuffed with 0xFF as per the standard.

If more than one channel is selected to use the same SPN, the HIGHEST temperature will always be sent. If one channel has an open-circuit, and the other(s) a valid temperature, the PGN will be sent with the temperature data AND a DM1 message will be sent indicating an open-circuit for that SPN. The error indicator data in the temperature message will only be sent if BOTH channels are showing an open-circuit at the same time. For this reason, setting up multiple channels for the same SPN should be used with caution.

1.4. Dimensions and Pinout

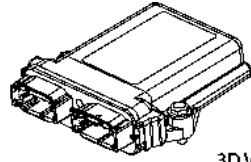

3D VIEW
Housing with 24 Pin Receptacle

HOUSING DIMENSIONS

Housing Material: High Temperature Nylon (Black)

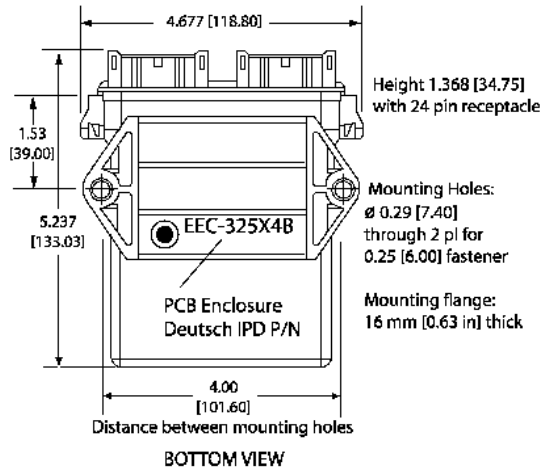

FRONT VIEW 24-PIN RECEPTACLE (NOT TO SCALE)

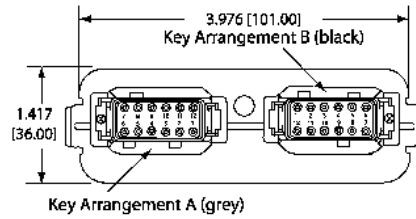

Mating Plug Assemblies for 24-pin receptacle:
Deutsch IPD P/N: DTM06-12SA and DTM06-12SB
with wedgelocks WM12S and contacts
(Contact factory for contact specification.)

Dimensions: inches [mm]
excluding mating plug(s)

Key Arrangement B (black)

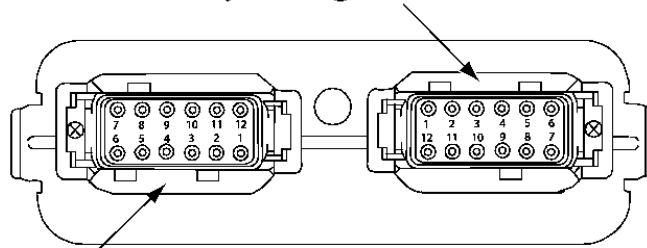

FRONT VIEW 24 PIN RECEPTACLE

Grey Connector		Black Connector	
Pin #	Function	Pin #	Function
1	RS-232 GND	1	Thermocouple 1 +
2	RS-232 TXD	2	Thermocouple 1 -
3	RS-232 RXD	3	Thermocouple 1 Shield
4	Not Used (plug)	4	Thermocouple 2 +
5	Frame GND	5	Thermocouple 2 -
6	Batt -	6	Thermocouple 2 Shield
7	Batt +	7	Thermocouple 3 Shield
8	Not Used (plug)	8	Thermocouple 3 -
9	Not Used (plug)	9	Thermocouple 3 +
10	CAN_L	10	Thermocouple 4 Shield
11	CAN_H	11	Thermocouple 4 -
12	CAN Shield	12	Thermocouple 4 +

Note: The Frame GND must be connected to the machine chassis.

2. DIAGNOSTIC MESSAGES

Each thermocouple channel could be configured to send diagnostic messages to the network if the temperature goes out of range, as described below.

When sending an “Active Diagnostic Trouble Code” (DM1) or a “Previously Active Diagnostic Trouble Codes” (DM2) message, the controller will use the appropriate Diagnostic Trouble Code (DTC). As defined by the standard, this is a combination of the Suspect Parameter Number (SPN), the Failure Mode Indicator (FMI), Occurrence Count (OC) and the SPN Conversion Method (CM).

The CM used by the Axiomatic controller is the recommend setting of 0. The SPN is a configurable setpoint, as described in section 3.1. Each channel will be associated with the four different FMIs, as described in sections 2.1. The OC for any DTC will be stored in a non-volatile diagnostic log, as described in section 2.2.

Regardless of whether or not there are any active DTCs, the ECU will send a DM1 message every one second as per the standard. If a previously inactive DTC becomes active, a DM1 will be sent immediately to reflect this. As soon as the last active DTC goes inactive, it will send a DM1 indicating that there are no more active DTCs.

If there is more than one active DTC at any given time, the regular DM1 message will be sent using a multipacket Broadcast Announce Message (BAM). If the controller receives a request for a DM1 while this is true, it will send the multipacket message to the Requester Address using the Transport Protocol (TP).

Previously active DTCs (a non-zero OC) are available upon request for a DM2 message. If there is more than one previously active DTC, the multipacket DM2 will be sent to the Requester Address using the Transport Protocol (TP).

See section 3.1 for a complete description of the J1939 Diagnostic setpoints and how changing them will affect if and how Diagnostic Messages (DM) will be sent to the J1939 bus.

2.1. Supported FMIs

There are four different FMIs that are associated with each thermocouple channel.

FMI#	FMI Name (J1939)	TC4 Function
0	Data Valid But Above Normal Operational Range – Most Severe	High Temperature Shutdown
15	Data Valid But Above Normal Operational Range – Least Severe	High Temperature Warning
17	Data Valid But Below Normal Operational Range – Least Severe	Low Temperature Warning
5	Current Below Normal or Open Circuit	Thermocouple Open Circuit

In the case of FMI=0, the *Red Stop Lamp* will be set. In all other cases, the *Amber Warning Lamp* will be set. It is possible to have both a High Temperature Warning and a High Temperature Shutdown active simultaneously on the same SPN, in which case both lamps would be set.

2.2. Diagnostic Log

In order to support requests for DM2, the controller stores diagnostic data in a non-volatile log. There are four diagnostic log entries associated with each input channel. Each entry is a record of the SPN, FMI and OC for any fault that has occurred.

If the “Generate Diagnostic Messages” setpoint for the thermocouple channel is set to false, the OC for any DTCs for that channel will NOT be updated in the log, even if the controller detects the associated fault.

As soon as the controller detects a new (previously inactive) fault, it will start decrementing the delay timer for that channel. If the fault has remained present during the delay time, then the controller will set the DTC to active, and will increment the OC in the log. A DM1 will immediately be generated that includes the new DTC. While there are any active DTCs, a DM1 will be sent every second, as per the standard.

If the controller receives a request for a “Diagnostic Data Clear/Reset for Previously Active DTCs” (DM3) it will clear the OC of ALL the inactive DTCs in the log. The OC for active diagnostics is not changed.

If the user changes the SPN associated with a thermocouple channel, the diagnostic entries for that channel are updated, and the OC for each type of fault is set to zero.

If more than one channel uses the same SPN, the occurrence count will only be incremented once, even if more than one channel detects the same fault at the same time.

2.3. Clearing Active DTCs

For a low temperature warning to be cleared, the temperature must go above the "Low Warning Temperature"+1°C. For a high temperature warning to be cleared, the temperature must go below the "High Warning Temperature"-1°C. For an open circuit to be cleared, a temperature within the thermocouple's range (dependent on type) must be measured.

For the above faults, all of which sets the *Amber Warning Lamp* when detected, if the fault goes away, then the controller automatically makes the SPN/FMI combination previously active, and will no longer include it in the DM1.

However, for a channel that has made the high temperature shutdown active, and sets the *Red Stop Lamp*, the DTC is NOT automatically made inactive once the fault clears. (By having the temperature drop below the "High Shutdown Temperature"-1°C.) Instead, it can only be cleared upon request for a “Diagnostic Data Clear/Reset for Active DTCs” (DM11).

Upon receiving a request for a DM11, the controller will check the status of all the active DTCs that set the *Red Stop Lamp*. If the fault is still present, then the DTC remains active. Otherwise, the DTC is made previously active, and it is no longer included in the DM1.

If any one of the *Red Stop Lamp* channels still has an active fault when the request for the DM11 is received, the controller will respond with a NAK, indicating that it was not able to complete the request. If, however, all the DTCs have now been made previously active, then it will respond with an ACK.

If all the faults in the module are cleared at this point, i.e. all DTCs are now inactive, the controller will send a DM1 message indicating that there are no longer any active DTCs.

3. ECU SETPOINTS

3.1. Thermocouple Setpoints

There are only two setpoints per channel that determine how data is measured and sent to the bus. The other eight setpoints are associated with if and how the ECU will send diagnostic messages for that channel.

Name	Range	Default	Notes
Temperature Suspect Parameter Number	See table below	TC1 = 1137 TC2 = 1138 TC3 = 1139 TC4 = 1140	Exhaust Gas Port 1 Temperature Exhaust Gas Port 2 Temperature Exhaust Gas Port 3 Temperature Exhaust Gas Port 4 Temperature
Thermocouple Type	Disabled J K T	K	Other types can be made available on request. Contact your Axiomatic sales rep.
Generate Diagnostic Messages	FALSE TRUE	TRUE	If set to false, no diagnostic messages will be sent to the bus for this channel, even if a fault is detected.
High Shutdown Temperature	Low Warning Temperature to 1735°C	250.0°C	If the measured temperature is greater than or equal to this value, FMI=0 will be come active after the timeout period.
High Warning Temperature	Low Warning Temperature to 1735°C	125.0°C	If the measured temperature is greater than or equal to this value, FMI=15 will be come active after the timeout period.
Low Warning Temperature	-200°C to High Warning Temperature	-20°C	If the measured temperature is less than or equal to this value, FMI=17 will be come active after the timeout period.
High Shutdown Delay	0 to 60 Seconds	5.000 Sec	If a temperature goes above the " High Shutdown Temperature" and stays above it for this length of time, the fault becomes active.
High Warning Delay	0 to 60 Seconds	5.000 Sec	If a temperature goes above the " High Warning Temperature" and stays above it for this length of time, the fault becomes active.
Low Warning Delay	0 to 60 Seconds	5.000 Sec	If a temperature goes below the " High Warning Temperature" and stays above it for this length of time, the fault becomes active.
Open Circuit Delay	0 to 60 Seconds	1.000 Sec	If an open circuit is measured and stays present for this length of time, the fault becomes active.

Name	Range	Default	Notes
Transmit PGN	0 to 65535	65280	This default is the start of the Proprietary B PGN range.
Transmit Repetition Rate	0 to 60000 ms	1000 ms	Default 0 ms means that the data will not be transmitted. Available only on request
Transmit Message Priority	0 to 7	6	Default priority for PropB messages
Destination Address (for PDU1)	0 to 255	254 (0xFE)	Not used by default, NULL address
Transmit Data Size	4 or 5	5 = 2-Bytes	Only 1 or 2 Byte data is supported
Transmit Data Index in Array (LSB)	1 to 8-Number of Data Bytes	TC1 = 1, TC2 = 3 TC3 = 5, TC4 = 7	Indexed from 1
Customized SPN (for Diagnostics)	1 to 524287	520192 + Channel Number - 1	The Channel 1 default 520192 = 0x7F000 is the start of the Proprietary SPN range

The setpoints shown on this page are only available if the “Temperature Suspect Parameter Number” is set to 0 = Undefined (User Selectable). When this is true, diagnostic trouble codes in DM1 or DM2 messages will be created using the “Customized SPN” setpoint.

Table 1: Supported Suspect Parameter Numbers

SPN	Description	Size	PGN	Rate	Index	Priority
52	Engine Intercooler Temperature	1	65262	1000	7	6
75	Steering Axle Temperature	1	65273	1000	1	6
79	Road Surface Temperature	2	65269	1000	7	6
90	Power Takeoff Oil Temperature	1	65264	100	1	6
105	Engine Intake Manifold 1 Temperature	1	65270	500	3	6
110	Engine Coolant Temperature	1	65262	1000	1	6
120	Hydraulic Retarded Oil Temperature	1	65275	1000	2	6
169	Cargo Ambient Temperature	2	65276	1000	5	6
170	Cab Interior Temperature	2	65269	1000	2	6
171	Ambient Air Temperature	2	65269	1000	4	6
172	Engine Air Inlet Temperature	1	65269	1000	6	6
173	Engine Exhaust Gas Temperature	2	65270	500	6	6
174	Engine Fuel Temperature 1	1	65262	1000	2	6
175	Engine Oil Temperature 1	2	65262	1000	3	6
176	Engine Turbocharger Oil Temperature	2	65262	1000	5	6
177	Transmission Oil Temperature	2	65272	1000	5	6
242	Tire Temperature	2	65268	10000	3	6
412	Engine Exhaust Gas Recirculation 1 Temperature	2	65188	1000	7	6
441	Auxiliary Temperature 1	1	65164	0	1	7
442	Auxiliary Temperature 2	1	65164	0	2	7
578	Drive Axle Temperature	1	65273	1000	4	6
1122	Engine Alternator Bearing 1 Temperature	1	65191	1000	1	7
1123	Engine Alternator Bearing 2 Temperature	1	65191	1000	2	7
1124	Engine Alternator Winding 1 Temperature	1	65191	1000	3	7
1125	Engine Alternator Winding 2 Temperature	1	65191	1000	4	7
1126	Engine Alternator Winding 3 Temperature	1	65191	1000	5	7
1131	Engine Intake Manifold 2 Temperature	1	65189	500	1	6
1132	Engine Intake Manifold 3 Temperature	1	65189	500	2	6
1133	Engine Intake Manifold 4 Temperature	1	65189	500	3	6
1135	Engine Oil Temperature 2	2	65188	1000	1	6
1136	Engine ECU Temperature	2	65188	1000	3	6

1137	Engine Exhaust Gas Port 1 Temperature	2	65187	1000	1	6
1138	Engine Exhaust Gas Port 2 Temperature	2	65187	1000	3	6
1139	Engine Exhaust Gas Port 3 Temperature	2	65187	1000	5	6
1140	Engine Exhaust Gas Port 4 Temperature	2	65187	1000	7	6
1141	Engine Exhaust Gas Port 5 Temperature	2	65186	1000	1	6
1142	Engine Exhaust Gas Port 6 Temperature	2	65186	1000	3	6
1143	Engine Exhaust Gas Port 7 Temperature	2	65186	1000	5	6
1144	Engine Exhaust Gas Port 8 Temperature	2	65186	1000	7	6
1145	Engine Exhaust Gas Port 9 Temperature	2	65185	1000	1	6
1146	Engine Exhaust Gas Port 10 Temperature	2	65185	1000	3	6
1147	Engine Exhaust Gas Port 11 Temperature	2	65185	1000	5	6
1148	Engine Exhaust Gas Port 12 Temperature	2	65185	1000	7	6
1149	Engine Exhaust Gas Port 13 Temperature	2	65184	1000	1	6
1150	Engine Exhaust Gas Port 14 Temperature	2	65184	1000	3	6
1151	Engine Exhaust Gas Port 15 Temperature	2	65184	1000	5	6
1152	Engine Exhaust Gas Port 16 Temperature	2	65184	1000	7	6
1153	Engine Exhaust Gas Port 17 Temperature	2	65183	1000	1	6
1154	Engine Exhaust Gas Port 18 Temperature	2	65183	1000	3	6
1155	Engine Exhaust Gas Port 19 Temperature	2	65183	1000	5	6
1156	Engine Exhaust Gas Port 20 Temperature	2	65183	1000	7	6
1157	Engine Main Bearing 1 Temperature	2	65182	1000	1	6
1158	Engine Main Bearing 2 Temperature	2	65182	1000	3	6
1159	Engine Main Bearing 3 Temperature	2	65182	1000	5	6
1160	Engine Main Bearing 4 Temperature	2	65182	1000	7	6
1161	Engine Main Bearing 5 Temperature	2	65181	1000	1	6
1162	Engine Main Bearing 6 Temperature	2	65181	1000	3	6
1163	Engine Main Bearing 7 Temperature	2	65181	1000	5	6
1164	Engine Main Bearing 8 Temperature	2	65181	1000	7	6
1165	Engine Main Bearing 9 Temperature	2	65180	1000	1	6
1166	Engine Main Bearing 10 Temperature	2	65180	1000	3	6
1167	Engine Main Bearing 11 Temperature	2	65180	1000	5	6
1172	Engine Turbocharger 1 Compressor Inlet Temperature	2	65178	1000	1	6
1173	Engine Turbocharger 2 Compressor Inlet Temperature	2	65178	1000	3	6
1174	Engine Turbocharger 3 Compressor Inlet Temperature	2	65178	1000	5	6
1175	Engine Turbocharger 4 Compressor Inlet Temperature	2	65178	1000	7	6
1180	Engine Turbocharger 1 Turbine Inlet Temperature	2	65176	1000	1	6
1181	Engine Turbocharger 2 Turbine Inlet Temperature	2	65176	1000	3	6
1182	Engine Turbocharger 3 Turbine Inlet Temperature	2	65176	1000	5	6
1183	Engine Turbocharger 4 Turbine Inlet Temperature	2	65176	1000	7	6
1184	Engine Turbocharger 1 Turbine Outlet Temperature	2	65175	1000	1	6
1185	Engine Turbocharger 2 Turbine Outlet Temperature	2	65175	1000	3	6
1186	Engine Turbocharger 3 Turbine Outlet Temperature	2	65175	1000	5	6
1187	Engine Turbocharger 4 Turbine Outlet Temperature	2	65175	1000	7	6
1212	Engine Auxiliary Coolant Temperature	1	65172	500	2	6
1636	Engine Intake Manifold 1 Air Temperature (High Resolution)	2	65129	1000	1	6
1637	Engine Coolant Temperature (High Resolution)	2	65129	1000	3	6
1638	Hydraulic Temperature	1	65128	1000	1	6
1687	Auxiliary Heater Outlet Coolant Temperature	1	65133	1000	1	6
1688	Auxiliary Heater Input Air Temperature	1	65133	1000	2	6
1800	Battery 1 Temperature	1	65104	1000	1	6

1801	Battery 2 Temperature	1	65104	1000	2	6
1802	Engine Intake Manifold 5 Temperature	1	65189	500	4	6
1803	Engine Intake Manifold 6 Temperature	1	65189	500	5	6
2433	Engine Exhaust Gas Temperature - Right Manifold	2	65031	500	1	6
2434	Engine Exhaust Gas Temperature - Left Manifold	2	65031	500	3	6
2629	Engine Turbocharger 1 Compressor Outlet Temperature	2	64979	1000	1	6
2630	Engine Charge Air Cooler 1 Outlet Temperature	2	65129	1000	7	6
2799	Engine Turbocharger 2 Compressor Outlet Temperature	2	64979	1000	3	6
2800	Engine Turbocharger 3 Compressor Outlet Temperature	2	64979	1000	5	6
2801	Engine Turbocharger 4 Compressor Outlet Temperature	2	64979	1000	7	6
2986	Engine Intake Valve Actuation System Oil Temperature	2	65129	1000	5	6
3031	Aftertreatment 1 SCR Catalyst Tank Temperature	1	65110	1000	2	6
3241	Aftertreatment 1 Exhaust Gas Temperature 1	2	64948	500	1	6
3242	Aftertreatment 1 Diesel Particulate Filter Intake Gas Temperature	2	64948	500	3	6
3245	Aftertreatment 1 Exhaust Gas Temperature 3	2	64947	500	1	6
3246	Aftertreatment 1 Diesel Particulate Filter Outlet Gas Temperature	2	64947	500	3	6
3249	Aftertreatment 1 Exhaust Gas Temperature 2	2	64946	500	1	6
3250	Aftertreatment 1 Diesel Particulate Filter Intermediate Gas Temperature	2	64946	500	3	6
3275	Aftertreatment 2 Exhaust Gas Temperature 1	2	64945	500	1	6
3276	Aftertreatment 2 Diesel Particulate Filter Intake Gas Temperature	2	64945	500	3	6
3279	Aftertreatment 2 Exhaust Gas Temperature 3	2	64944	500	1	6
3280	Aftertreatment 2 Diesel Particulate Filter Outlet Gas Temperature	2	64944	500	3	6
3283	Aftertreatment 2 Exhaust Gas Temperature 2	2	64943	500	1	6
3284	Aftertreatment 2 Diesel Particulate Filter Intermediate Gas Temperature	2	64943	500	3	6
3468	Engine Fuel Temperature 2	1	64930	500	5	4
3515	Aftertreatment 1 SCR Catalyst Reagent Temperature 2	1	64923	1000	1	6
3823	Transmission Torque Converter Oil Outlet Temperature	2	64917	1000	2	6
3831	Aftertreatment 1 Secondary Air Temperature	2	64877	500	3	6
3834	Aftertreatment 2 Secondary Air Temperature	2	64876	500	3	6
4076	Engine Coolant Temperature 2	1	64870	1000	1	6
4151	Engine Exhaust Gas Temperature Average	2	64851	500	1	5
4152	Engine Exhaust Gas Temperature Average - Bank 2	2	64851	500	3	5
4153	Engine Exhaust Gas Temperature Average - Bank 1	2	64851	500	5	5
4193	Engine Coolant Pump Outlet Temperature	1	64870	1000	2	6
4288	Engine Exhaust Valve Actuation System Oil Temperature	2	64870	1000	4	6
4289	Aftertreatment 1 Three Way Catalytic Converter Intake Gas Temperature	2	64838	500	1	6
4290	Aftertreatment 1 Three Way Catalytic Converter Outlet Gas Temperature	2	64838	500	3	6
4295	Aftertreatment 2 Three Way Catalytic Converter Intake Gas Temperature	2	64837	500	1	6
4296	Aftertreatment 2 Three Way Catalytic Converter Outlet Gas Temperature	2	64837	500	3	6
4337	Aftertreatment 1 SCR Dosing Reagent Temperature	1	64833	500	3	6
4360	Aftertreatment 1 SCR Catalyst Intake Gas Temperature	2	64830	500	1	6
4363	Aftertreatment 1 SCR Catalyst Outlet Gas Temperature	2	64830	500	4	6
4368	Aftertreatment 1 SCR Catalyst Reagent Tank 2 Temperature	1	64829	1000	2	6
4390	Aftertreatment 2 SCR Dosing Reagent Temperature	1	64827	500	3	6
4413	Aftertreatment 2 SCR Catalyst Intake Gas Temperature	2	64824	500	1	6
4415	Aftertreatment 2 SCR Catalyst Outlet Gas Temperature	2	64824	500	4	6
4420	Aftertreatment 2 SCR Catalyst Reagent Temperature 2	1	64822	1000	1	6
4427	Aftertreatment 2 SCR Catalyst Tank Temperature	1	64821	1000	2	6
4434	Aftertreatment 2 SCR Catalyst Reagent Tank 2 Temperature	1	64820	1000	2	6
4750	Engine Exhaust Gas Recirculation 1 (EGR1) Cooler Intake Temperature	2	64879	0	3	6
4753	Aftertreatment 1 Gas Oxidation Catalyst Intake Gas Temperature	2	64802	500	1	6

4754	Aftertreatment 1 Gas Oxidation Catalyst Outlet Gas Temperature	2	64802	500	3	6
4759	Aftertreatment 2 Gas Oxidation Catalyst Intake Gas Temperature	2	64801	500	1	6
4760	Aftertreatment 2 Gas Oxidation Catalyst Outlet Gas Temperature	2	64801	500	3	6
4765	Aftertreatment 1 Diesel Oxidation Catalyst Intake Gas Temperature	2	64800	500	1	6
4766	Aftertreatment 1 Diesel Oxidation Catalyst Outlet Gas Temperature	2	64800	500	3	6
4771	Aftertreatment 2 Diesel Oxidation Catalyst Intake Gas Temperature	2	64799	500	1	6
4772	Aftertreatment 2 Diesel Oxidation Catalyst Outlet Gas Temperature	2	64799	500	3	6
4809	Aftertreatment 1 Warm Up Diesel Oxidation Catalyst Intake Temperature	2	64794	500	1	6
4810	Aftertreatment 1 Warm Up Diesel Oxidation Catalyst Outlet Temperature	2	64794	500	3	6
5020	Engine Exhaust Gas Recirculation 1 (EGR1) Mixer Intake Temperature	2	64870	1000	6	6
5148	Low Voltage Disconnect Temperature	1	64769	500	4	6
5255	Engine Exhaust Gas Recirculation 2 (EGR2) Temperature	2	64767	1000	1	6
5256	Engine Exhaust Gas Recirculation 2 (EGR2) Mixer Intake Temperature	2	64767	1000	3	6
5258	Engine Exhaust Gas Recirculation 2 (EGR2) Cooler Intake Temperature	2	64766	0	1	6
5280	Engine Charge Air Cooler 1 Precooler Intake Temperature	2	64759	1000	1	6
5281	Engine Charge Air Cooler 1 Precooler Outlet Temperature	2	64759	1000	3	6
5283	Engine Charge Air Cooler 1 Intake Temperature	2	64758	1000	1	6
5284	Engine Charge Air Cooler 1 Ambient Air Temperature	2	64758	1000	3	6
5286	Engine Charge Air Cooler 2 Precooler Intake Temperature	2	64757	1000	1	6
5287	Engine Charge Air Cooler 2 Precooler Outlet Temperature	2	64757	1000	3	6
5289	Engine Charge Air Cooler 2 Intake Temperature	2	64756	1000	1	6
5290	Engine Charge Air Cooler 2 Outlet Temperature	2	64756	1000	3	6
5291	Engine Charge Air Cooler 2 Ambient Air Temperature	2	64756	1000	5	6
5315	Aftertreatment 2 Warm Up Diesel Oxidation Catalyst Intake Temperature	2	64749	500	1	6
5316	Aftertreatment 2 Warm Up Diesel Oxidation Catalyst Outlet Temperature	2	64749	500	3	6
5456	Aftertreatment 1 Hydrocarbon Doser Intake Fuel Temperature	1	64869	500	6	6

3.2. Miscellaneous Setpoints

NAME Setpoints

The TC4 ECU has the following defaults for the J1939 NAME. The user should refer to the SAE J1939/81 standard for more information on these parameters and their ranges.

Arbitrary Address Capable	Yes
Industry Group	5, Industrial Process Control, Stationary (Gen-Sets)
Vehicle System Instance	0
Vehicle System	0, Non-specific system
Function	128, Supplemental Engine Control Sensing
Function Instance	3, Axiomatic AXTC4
ECU Instance	0, First Instance
Manufacture Code	162, Axiomatic Technologies Corporation
Identity Number	Variable, based on ECU Serial Number

The only configurable setpoint associated with the NAME is the ECU Instance. Changing this value will allow multiple ECUs of this type to be distinguishable by other ECUs (including Axiomatic Electronic Assistant) when they are all connected on the same network.

ECU Address

With this setpoint, the user can change the address of the ECU. The default value of this setpoint is 235 (0xEB), Supplemental Sensor Processing Unit#1, as set by the SAE in J1939 tables B3 to B7. The Axiomatic EA supports the selection of any address between 0 to 253, and ***it is the user's responsibility to select an address that complies with the standard.*** The user must also be aware that since the unit is arbitrary address capable, if another ECU with a higher priority NAME contends for the selected address, the module will continue select the next highest address until it finds one that it can claim. See J1939/81 for more details about address claiming.

Filter Frequency

As described in section 1.2, the analog-to-digital converter has programmable rejection for line frequency. This setpoint allows the user to select either 50Hz or 60Hz as appropriate, and has a default value of 60Hz.

Averaging Setpoints

If desired, averaging can be enabled such that the average temperature of all active channels, the average temperature of Bank 1 (channels 1 and 2), and the average temperature of Bank 2 (channels 3 and 4) can be broadcasted on the J1939 network. The PGN on which the data is sent, and the repetition rate at which is sent is user configurable. However, the structure of the data in the 'Averaging' message is fixed in the order shown below. All average temperatures are sent as WORD (2 byte) data with 0.03125°C/bit resolution and a -273°C offset.

PGN 64851 Engine Average Information			
Transmission Repetition:	500ms	(user configurable)	
Data Length:	8		
Data Page:	0		
PDU Format:	253		
PDU Specific:	83	PGN Supporting Information:	
Default Priority:	5		
Parameter Group Number:	64851 (0xFD53)	(user configurable)	
Start Position	Length	Parameter Name	SPN
1-2	2 bytes	Engine Exhaust Gas Temperature Average	4151
3-4	2 bytes	Engine Exhaust Gas Temperature Average – Bank 1	4153
5-6	2 bytes	Engine Exhaust Gas Temperature Average – Bank 2	4152

Name	Range	Default	Notes
Averaging Enabled	FALSE or TRUE	FALSE	If set to false, the averaging message will not be sent to the bus.
Averaging PGN	0 to 65535	64851 (0xFD53)	Per J1939-71, January 2009
Averaging Repetition Rate	100ms to 60000 ms	500 ms	Determines how often the averaging message will be sent to the network

4. USING ECU WITH AXIOMATIC ELECTRONIC ASSISTANT

4.1. Installing the Axiomatic Electronic Assistant

For instruction on how to install and use the Axiomatic Electronic Assistant (EA), refer to User Manual AX07050x.

4.2. Screen Captures

Image 5.1: CAN port was opened, programmer has recognized the Axiomatic ECU

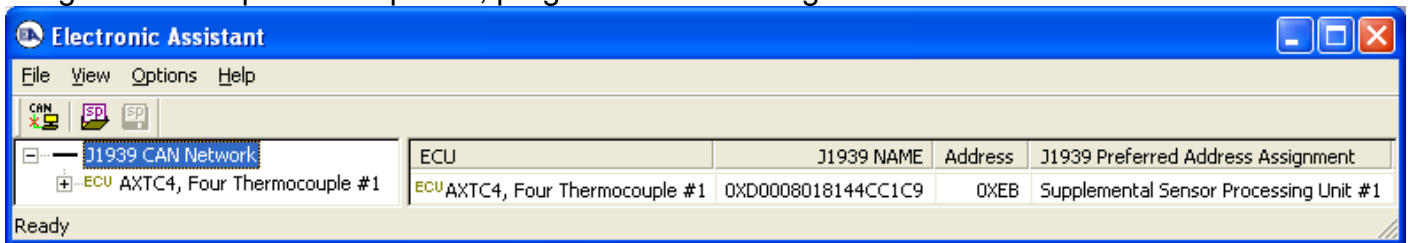
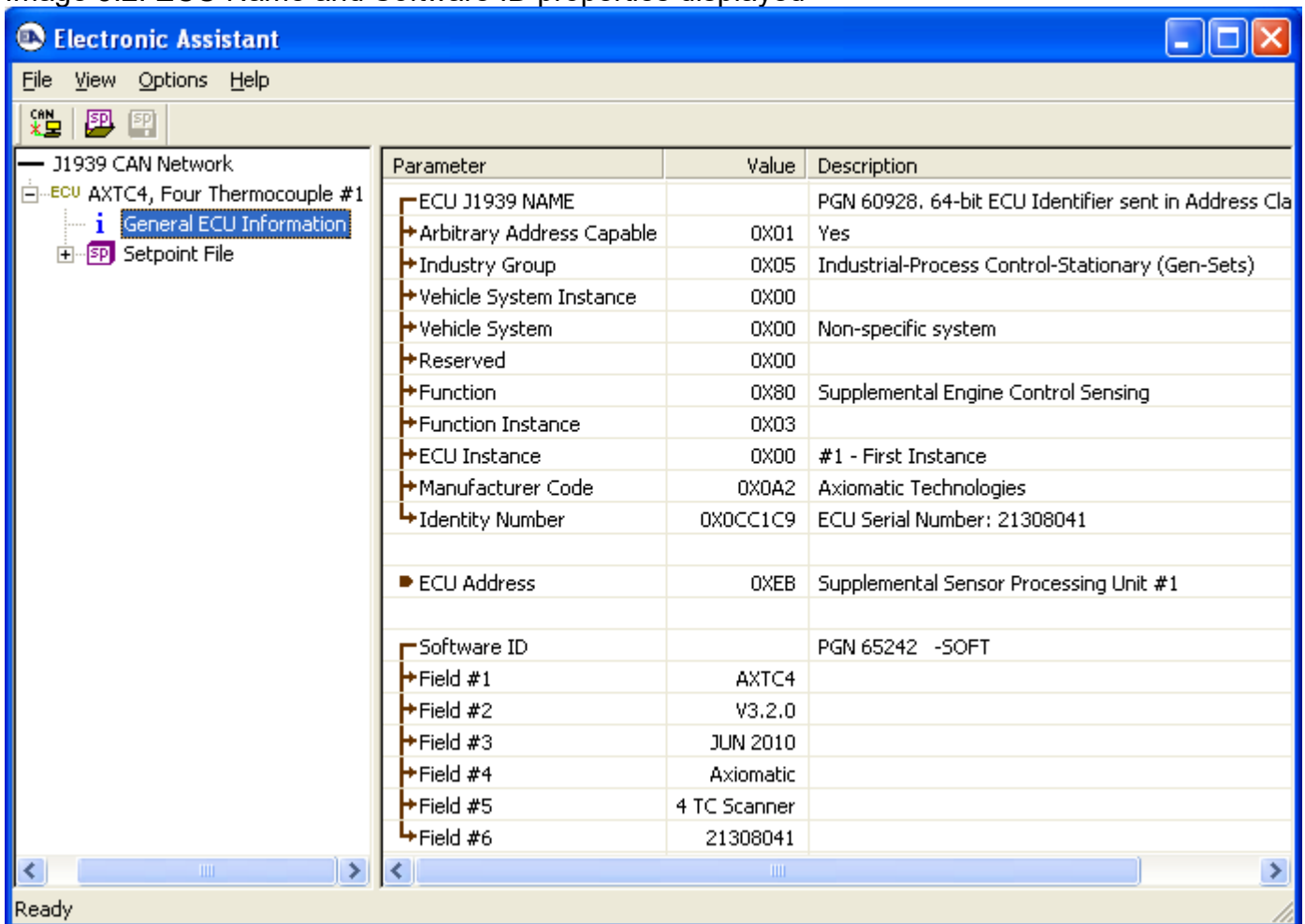

Image 5.2: ECU Name and Software ID properties displayed



For the AXTC4 Software ID, the data in the fields are as follows:

(Part Number)*(Version)*(Date)*(Owner)*(Description)*(Serial Number)

Image 5.3: Miscellaneous Setpoints

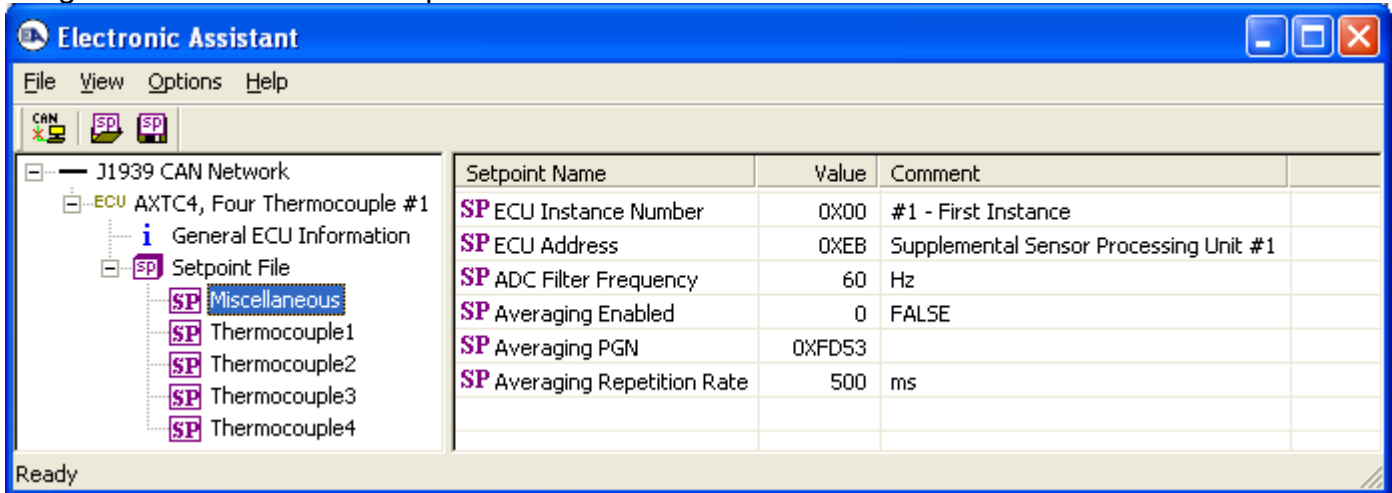

Image 5.4: Input Channel Setpoints – Defaults for Channel 1

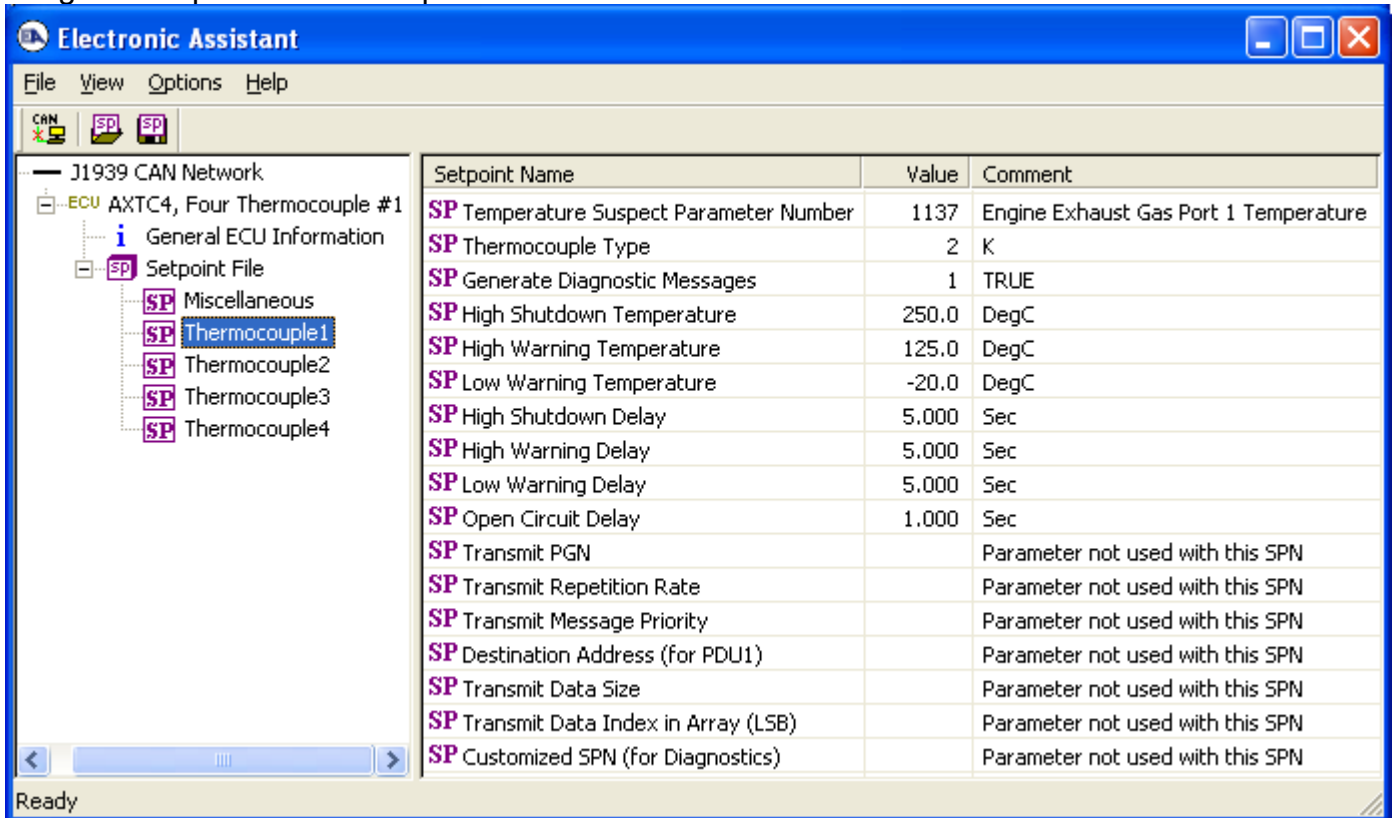

Image 5.5: Input Channel Setpoints – User Defined Defaults for Channel 1

The screenshot shows the 'Electronic Assistant' software window. The left-hand tree view is expanded to show the 'Setpoint File' for 'ECU AXTC4, Four Thermocouple #1', listing 'Miscellaneous' and four 'Thermocouple' entries. The main pane displays a table of user-defined defaults for Channel 1.

Setpoint Name	Value	Comment
SP Temperature Suspect Parameter Number	0	Undefined (User Selectable)
SP Thermocouple Type	2	K
SP Generate Diagnostic Messages	1	TRUE
SP High Shutdown Temperature	250.0	DegC
SP High Warning Temperature	125.0	DegC
SP Low Warning Temperature	-20.0	DegC
SP High Shutdown Delay	5.000	Sec
SP High Warning Delay	5.000	Sec
SP Low Warning Delay	5.000	Sec
SP Open Circuit Delay	1.000	Sec
SP Transmit PGN	0XFF00	
SP Transmit Repetition Rate	1000	ms
SP Transmit Message Priority	6	
SP Destination Address (for PDU1)		Parameter not used with this PGN
SP Transmit Data Size	5	2-Bytes
SP Transmit Data Index in Array (LSB)	1	
SP Customized SPN (for Diagnostics)	0X0007F000	

The status bar at the bottom left of the window displays 'Ready'.

APPENDIX A – TECHNICAL SPECIFICATIONS

Input Specifications

Power Supply Input	12V or 24Vdc nominal (9...36Vdc power supply range) NB. The maximum total power consumption is <1.5 Watts.
Protection	Surge and reverse polarity protection are provided.
Isolation	Full isolation of each channel from the CAN line, other inputs and power supply. Isolation voltage is 1500 Vac (rms) or 2550V for 1 sec. for all channels to power and 50V (rms) for all channels to CAN interface.
All Inputs	4 Type J or K or T Thermocouple Modules (other types on request) All input channels are completely independent of each other and can read the thermocouple temperatures at the same time. Temperature is measured in °C with a 0.1°C resolution. All inputs send a message to the J1939 bus. There are 2 setpoints for each channel that are associated with the input and how the data is measured. Channels are configured to indicate the SAE J1939 SPN to transmit the temperature measured by that input. The Parameter Group Number (PGN) that will be used to send a temperature to the J1939 network is dependant on the Suspect Parameter Number (SPN) that was selected for that channel. Refer to the section on Thermocouple Inputs for a list of supported SPN's. Regardless of the SPN selected, temperature is always available for the associated PGN. The AXTC4 supports all the temperature SPNs as defined in J1939-71 as of January 2009. In order to allow for future expansion, the user can select a "User Defined" SPN (0) which enables a variety of setpoints associated with transmitting the data on the network. This allows the user to select the PGN, size (1 or 2 bytes), data index and repetition rate of the message that will broadcast the temperature for the selected channel.
Measurement Rate	The measurement rate is 5 scans/Sec. All channels are measured simultaneously. The update rate is 200 mSec.
Common Mode	Common mode rejection is >110 db@ 5V p-p (programmable for either 50 or 60 Hz). Common mode input range is +/- 4 V minimum.
Resolution	Temperature data is measured with a resolution of 0.1 °C. When sending data to the J1939 bus, one byte parameters have a resolution of 1°C/ bit, an offset of -40°C and a range of -40 °C to 210 °C. Two byte parameters have resolution of 0.03125 °C / bit and a range of -273 °C to 1735 °C.
Drift	Overall drift with temperature is 50ppm/°C of span (maximum).
Accuracy	+/-1 °C throughout the entire range of the thermocouple input
Input Configuration	Refer to the section on Thermocouple Inputs for details.
Shield	Four shield connections are provided.
Ground	Four analog ground connections are provided.

General Specifications

Operating Conditions	-40 to 85°C (-40 to 185°F)
Weight	0.55 lb. (0.25 kg)
Protection	IP67; Unit is conformal coated within the housing.
Microprocessor	Motorola DSP56F8346
Vibration	MIL-STD-202G, Test 204D and 214A (Sine and Random) 10 g peak (Sine) 7.68 Grms peak (Random)
Shock	MIL-STD-202G, Test 213B 50 g
Control Logic	Standard embedded software is provided. (Application-specific control logic is available on request.)
RS-232 Port	The controller's RS232 port interfaces to a serial port (i.e. COM1) on a PC (115200 Baud Rate, N81, Xon/Xoff Flow Control). If the Axiomatic plug kit with a built-in RS-232 connector is not used, then the end user can make a RS-232 cable with the following pinout. Controller Grey Connector, Pin 2 -> TXD -> female DB-9 Pin 2 Controller Grey Connector, Pin 3 -> RXD -> female DB-9 Pin 3 Controller Grey Connector Pin 1 -> GND -> female DB-9 Pin 5
CAN Port	1 SAE J1939 (CANopen® on request)
User Interface	The Axiomatic Electronic Assistant for <i>Windows</i> operating systems It comes with a royalty-free license for use.
Enclosure and Dimensions	Refer to the Installation Instructions Section.
Electrical Connections	Refer to the Installation Instructions Section.

Note: CANopen® is a registered community trademark of CAN in Automation e.V.

OUR PRODUCTS

AC/DC Power Supplies
Actuator Controls/Interfaces
Automotive Ethernet Interfaces
Battery Chargers
CAN Controls, Routers, Repeaters
CAN/WiFi, CAN/Bluetooth, Routers
Current/Voltage/PWM Converters
DC/DC Power Converters
Engine Temperature Scanners
Ethernet/CAN Converters,
Gateways, Switches
Fan Drive Controllers
Gateways, CAN/Modbus, RS-232
Gyroscopes, Inclinometers
Hydraulic Valve Controllers
Inclinometers, Triaxial
I/O Controls
LVDT Signal Converters
Machine Controls
Modbus, RS-422, RS-485 Controls
Motor Controls, Inverters
Power Supplies, DC/DC, AC/DC
PWM Signal Converters/Isolators
Resolver Signal Conditioners
Service Tools
Signal Conditioners, Converters
Strain Gauge CAN Controls
Surge Suppressors

OUR COMPANY

Axiomatic provides electronic machine control components to the off-highway, commercial vehicle, electric vehicle, power generator set, material handling, renewable energy and industrial OEM markets. ***We innovate with engineered and off-the-shelf machine controls that add value for our customers.***

QUALITY DESIGN AND MANUFACTURING

We have an ISO9001:2015 registered design/manufacturing facility in Canada.

WARRANTY, APPLICATION APPROVALS/LIMITATIONS

Axiomatic Technologies Corporation reserves the right to make corrections, modifications, enhancements, improvements, and other changes to its products and services at any time and to discontinue any product or service without notice. Customers should obtain the latest relevant information before placing orders and should verify that such information is current and complete. Users should satisfy themselves that the product is suitable for use in the intended application. All our products carry a limited warranty against defects in material and workmanship. Please refer to our Warranty, Application Approvals/Limitations and Return Materials Process at <https://www.axiomatic.com/service/>.

COMPLIANCE

Product compliance details can be found in the product literature and/or on axiomatic.com. Any inquiries should be sent to sales@axiomatic.com.

SAFE USE

All products should be serviced by Axiomatic. Do not open the product and perform the service yourself.



This product can expose you to chemicals which are known in the State of California, USA to cause cancer and reproductive harm. For more information go to www.P65Warnings.ca.gov.

SERVICE

All products to be returned to Axiomatic require a Return Materials Authorization Number (RMA#) from sales@axiomatic.com. Please provide the following information when requesting an RMA number:

- Serial number, part number
- Runtime hours, description of problem
- Wiring set up diagram, application and other comments as needed

DISPOSAL

Axiomatic products are electronic waste. Please follow your local environmental waste and recycling laws, regulations and policies for safe disposal or recycling of electronic waste.

CONTACTS

Axiomatic Technologies Corporation
1445 Courtneypark Drive E.
Mississauga, ON
CANADA L5T 2E3
TEL: +1 905 602 9270
FAX: +1 905 602 9279
www.axiomatic.com
sales@axiomatic.com

Axiomatic Technologies Oy
Höytämöntie 6
33880 Lempäälä
FINLAND
TEL: +358 103 375 750
www.axiomatic.com
salesfinland@axiomatic.com