

4-CHANNEL STRAIN GAUGE CONTROLLER

With CANopen®

USER MANUAL

P/N: AX200301

ACRONYMS

AO	Analog Output (Universal)
CAN	Controller Area Network
CANopen®	CANopen® is a registered community trademark of CAN in Automation e.V.
CAN-ID	CAN 11-bit Identifier
COB	Communication Object
CTRL	Control
DO	Digital Output
EDS	Electronic Data Sheet
EMCY	Emergency
LSB	Least Significant Byte (or Bit)
LSS	Layer Settling Service
LUT	Lookup Table
MSB	Most Significant Byte (or Bit)
NMT	Network Management
PID	Proportional-Integral-Derivative Control
RO	Read Only Object
RPDO	Received Process Data Object
RW	Read/Write Object
SDO	Service Data Object
TPDO	Transmitted Process Data Object
WO	Write Only Object

REFERENCES

- [DS-301] CiA DS-301 V4.1 – CANopen® Application Layer and Communication Profile. CAN in Automation 2005
- [DS-305] CiA DS-305 V2.0 – Layer Setting Service (LSS) and Protocols. CAN in Automation 2006
- [DS-404] CiA DS-404 V1.2 – CANopen® profile for Measurement Devices and Closed Loop Controllers. CAN in Automation 2002

These documents are available from the CAN in Automation e.V. website <http://www.can-cia.org/>.

TABLE OF CONTENTS

1. OVERVIEW OF CONTROLLER	7
1.1. DESCRIPTION OF 4-CHANNEL STRAIN GAUGE INPUT CONTROLLER	7
1.2. STRAIN GAUGE ADC FUNCTION BLOCK	10
1.3. STRAIN GAUGE INPUT FUNCTION BLOCK	10
1.4. TARE/CALIBRATION INPUT FUNCTION BLOCK	11
1.4.1. Digital Input Setpoints	12
1.4.2. Tare/Calibrate Functionality	12
1.5. INTERNAL FUNCTION BLOCK CONTROL SOURCES	14
1.6. DIGITAL / ANALOG & INTERLOCK OUTPUTS FUNCTION BLOCKS	15
1.6.1. Output Override	16
1.6.2. Output Enable	17
1.6.3. Output Control	18
1.6.4. Output Unlatch	18
1.7. MISCELLANEOUS FUNCTION BLOCK	19
1.8. CAN TARE FUNCTION BLOCK	19
1.9. LOOKUP TABLE FUNCTION BLOCK	20
1.9.1. X-Axis, Input Data Response	21
1.9.2. Y-Axis, Lookup Table Output	21
1.9.3. Default Configuration, Data Response	21
1.9.4. Point To Point Response	22
1.9.5. X-Axis, Time Response	23
1.10. PROGRAMMABLE LOGIC FUNCTION BLOCKS	25
1.10.1. Conditions Evaluation	28
1.10.2. Table Selection	29
1.10.3. Logic Block Output	30
1.11. MATH FUNCTION BLOCKS	30
1.12. SIMPLE CONDITIONAL LOGIC FUNCTION BLOCKS	32
1.13. SET / RESET LATCH FUNCTION BLOCKS	33
2. INSTALLATION INSTRUCTIONS	34
2.1. DIMENSIONS AND PINOUT	34
2.2. MOUNTING INSTRUCTIONS	35
2.2.1. Notes & Warnings	35
2.2.2. Mounting	35
2.2.3. Connections	35
3. CANOPEN® OBJECT DICTIONARY	36
3.1. NODE ID AND BAUDRATE	36
3.1.1. LSS Protocol to Update	36
3.2. COMMUNICATION OBJECTS (DS-301 AND DS-404)	39
3.2.1. Object 1000h: Device Type	40
3.2.2. Object 1001h: Error Register	41
3.2.3. Object 1002h: Manufacturer Status Register	41
3.2.4. Object 1003h: Pre-Defined Error Field	41
3.2.5. Object 100Ch: Guard Time	43
3.2.6. Object 100Dh: Lifetime Factor	43
3.2.7. Object 1010h: Store Parameters	44
3.2.8. Object 1011h: Restore Parameters	45
3.2.9. Object 1016h: Consumer Heartbeat Time	46
3.2.10. Object 1017h: Producer Heartbeat Time	47
3.2.11. Object 1018h: Identity Object	47
3.2.12. Object 1020h: Verify Configuration	48
3.2.13. Object 1029h: Error Behaviour	49
3.2.14. RPDO Behaviour	51
3.2.15. TPDO Behaviour	53
3.3. APPLICATION OBJECTS (DS-404)	56

3.3.1.	Object 6020h: DI Read State	56
3.3.2.	Object 6030h: DI Polarity	56
3.3.3.	Object 6220h: DO Write State.....	57
3.3.4.	Object 6302h: AO Decimal Digits PV	57
3.3.5.	Object 6332h: AO Decimal Digits FV	58
3.3.6.	Object 7300h: AO Output Process Value	59
3.3.7.	Object 7320h: AO Output Scaling 1 PV	59
3.3.8.	Object 7321h: AO Output Scaling 1 FV.....	60
3.3.9.	Object 7322h: AO Output Scaling 2 PV	60
3.3.10.	Object 7323h: AO Output Scaling 2 FV.....	61
3.3.11.	Object 7330h: AO Output Field Value	61
3.4.	MANUFACTURER OBJECTS.....	62
3.4.1.	Object 2020h: DI Pull Up/Down Mode.....	64
3.4.2.	Object 2040h: DI Digital Output Feedback.....	64
3.4.3.	Object 2050h: DI Long Press Time.....	65
3.4.4.	Object 2060h: DI One Press Operation	65
3.4.5.	Object 2070h: DI Two Press Operation	66
3.4.6.	Object 2080h: DI Three Press Operation.....	66
3.4.7.	Object 2090h: DI Four Press Operation.....	67
3.4.8.	Object 20A0h: DI Time Between Presses	67
3.4.9.	Object 2100h: SGADC Enabled	68
3.4.10.	Object 2101h: SGADC Digital Filter	68
3.4.11.	Object 2102h: SGADC Data Rate	68
3.4.12.	Object 2103h: SGADC Gain Select	69
3.4.13.	Object 2104h: SGADC Burnout Time.....	69
3.4.14.	Object 2105h: SGADC Error Detect Enable	69
3.4.15.	Object 2106h: SGADC Error React Delay.....	70
3.4.16.	Object 2110h: SGIN Weight Units	70
3.4.17.	Object 2111h: SGIN Auto Null	70
3.4.18.	Object 2112h: SGIN Auto Null Offset	71
3.4.19.	Object 2113h: SGIN Rated Weight	71
3.4.20.	Object 2114h: SGIN Sensitivity.....	72
3.4.21.	Object 2115h: SGIN Minimum Range.....	73
3.4.22.	Object 2116h: SGIN Maximum Range	73
3.4.23.	Object 2117h: SGIN Minimum Error	74
3.4.24.	Object 2118h: SGIN Maximum Error.....	74
3.4.25.	Object 2119h: SGIN Error Detect Enable.....	75
3.4.26.	Object 211Ah: SGIN Error Clear Hysteresis	75
3.4.27.	Object 211Bh: SGIN Error React Delay	76
3.4.28.	Object 211Ch: SGIN Input FV	76
3.4.29.	Object 211Dh: SGIN mV Input PV.....	77
3.4.30.	Object 211Eh: SGIN Weight Input PV.....	77
3.4.31.	Object 211Fh: SGIN Decimal Digits PV	78
3.4.32.	Object 2200h: AO DO Output Type	78
3.4.33.	Object 2210h: AO DO Control Source	79
3.4.34.	Object 2211h: AO DO Control Number	79
3.4.35.	Object 2230h: DO Logic Type	80
3.4.36.	Object 2231h: DO Toggle Frequency.....	80
3.4.37.	Object 2235h: DO Off State Delay.....	81
3.4.38.	Object 2236h: DO On State Delay	81
3.4.39.	Object 2250h: DO Enable Source	82
3.4.40.	Object 2251h: DO Enable Number	82
3.4.41.	Object 2252h: DO Enable Response.....	83
3.4.42.	Object 2253h: DO Enable Response Delay	83
3.4.43.	Object 2260h: DO Override Source	84
3.4.44.	Object 2261h: DO Override Number.....	84
3.4.45.	Object 2262h: DO Override Response	85

3.4.46.	Object 2263h: DO Override State.....	85
3.4.47.	Object 2270h: DO Unlatch Source	86
3.4.48.	Object 2271h: DO Unlatch Number	87
3.4.49.	Object 2310h: AO Error Detect Enable	87
3.4.50.	Object 2311h: AO Error Clear Hysteresis	88
3.4.51.	Object 2312h: AO Error React Delay	88
3.4.52.	Object 2320h: AO Output Range.....	89
3.4.53.	Object 2321h: AO Slew Rate Control	89
3.4.54.	Object 2322h: AO Slew Rate Step Options.....	90
3.4.55.	Object 2323h: AO Slew Rate Clock Options	90
3.4.56.	Object 2380h: AO Output Frequency.....	91
3.4.57.	Object 2400h: RLY Output Type	91
3.4.58.	Object 2401h: RLY Logic Type	92
3.4.59.	Object 2402h: RLY Toggle Frequency.....	92
3.4.60.	Object 2405h: RLY Off State Delay	93
3.4.61.	Object 2406h: RLY On State Delay	93
3.4.62.	Object 2407h: RLY Write State	94
3.4.63.	Object 2410h: RLY Control Source	94
3.4.64.	Object 2411h: RLY Control Number	95
3.4.65.	Object 2420h: RLY Enable Source	95
3.4.66.	Object 2421h: RLY Enable Number	96
3.4.67.	Object 2422h: RLY Enable Response	96
3.4.68.	Object 2423h: RLY Enable Response Delay	97
3.4.69.	Object 2430h: RLY Override Source	97
3.4.70.	Object 2431h: RLY Override Number	98
3.4.71.	Object 2432h: RLY Override Response.....	98
3.4.72.	Object 2433h: RLY Override State	99
3.4.73.	Object 24400h: RLY Unlatch Source.....	100
3.4.74.	Object 2441h: RLY Unlatch Number.....	100
3.4.75.	Object 2500h: EC Extra Received Process Value	101
3.4.76.	Object 2502h: EC Decimal Digits PV.....	101
3.4.77.	Object 2520h: EC Scaling 1 PV.....	102
3.4.78.	Object 2522h: EC Scaling 2 PV.....	102
3.4.79.	Object 2600h: CAN Tare.....	103
3.4.80.	Object 5010h: Constant Field Value.....	103
3.4.81.	Object 5020h: Power Supply Field Value	106
3.4.82.	Object 5030h: Processor Temperature Field Value	106
3.4.83.	Object 5550h: Enable Automatic Updates	107
3.4.84.	Object 5555h: Start in Operational Mode.....	107
3.5.	LOGIC OBJECTS	107
3.5.1.	Object 30y0h: Lookup Table y Input X-Axis Source	109
3.5.2.	Object 30y1h: Lookup Table y Input X-Axis Number.....	109
3.5.3.	Object 30y2h: Lookup Table y Auto Repeat	109
3.5.4.	Object 30y3h: Lookup Table y X-Axis Decimal Digits PV	110
3.5.5.	Object 30y4h: Lookup Table y Y-Axis Decimal Digits PV	110
3.5.6.	Object 30y5h: Lookup Table y Point Response	111
3.5.7.	Object 30y6h: Lookup Table y Point X-Axis PV.....	111
3.5.8.	Object 30y7h: Lookup Table y Point Y-Axis PV	112
3.5.9.	Object 30y8h: Lookup Table y Output Y-Axis PV.....	113
3.5.10.	Object 3300h: Logic Block Enable	113
3.5.11.	Object 3310h: Logic Block Selected Table.....	113
3.5.12.	Object 3320h: Logic Block Output PV.....	114
3.5.13.	Object 3x01h: Logic Block (x-3) Lookup Table Numbers	114
3.5.14.	Object 3x02h: Logic Block (x-3) Function Logical Operator.....	115
3.5.24.	Object 4000h: Math Function Enable	117
3.5.25.	Object 4021h: Math Output Scaling 1 PV.....	117
3.5.26.	Object 4023h: Math Output Scaling 2 PV.....	118

- 3.5.27. Object 4030h: Math Output PV..... 119
- 3.5.28. Object 4032h: Math Output Decimal Digits PV 119
- 3.5.29. Object 4y00h: Math Y Input Source 120
- 3.5.30. Object 4y01h: Math Y Input Number 120
- 3.5.31. Object 4y02h: Math Y Input Function Number 121
- 3.5.32. Object 4y03h: Math Y Input Decimal Digits FV 121
- 3.5.33. Object 4y20h: Math Y Input Scaling 1 FV 122
- 3.5.35. Object 4y40h: Math Y Input Gain 123
- 3.5.36. Object 4y50h: Math Y Operator 124
- 3.5.37. Object 4500h: COND LOGIC Enabled 124
- 3.5.38. Object 4501h: COND LOGIC Output PV..... 125
- 3.5.39. Object 4y10h: COND LOGIC (y-4) Result Operator..... 125
- 3.5.40. Object 4y20h: COND LOGIC (y-4) Condition 1..... 126
- 3.5.41. Object 4y25h: COND LOGIC (y-4) Condition 2..... 126
- 3.5.42. Object 4Fy0h: SRL (y+1) Enabled..... 127
- 3.5.43. Object 4Fy1h: SRL (y+1) Set Control Source..... 127
- 3.5.44. Object 4Fy2h: SRL (y+1) Set Control Number..... 127
- 3.5.45. Object 4Fy3h: SRL (y+1) Reset Control Source..... 128
- 3.5.46. Object 4Fy4h: SRL (y+1) Reset Control Number..... 128
- 3.5.47. Object 4Fy5h: SRL (y+1) Set Input On Percent 128
- 3.5.48. Object 4Fy6h: SRL (y+1) Reset Input On Percent 129
- 3.5.49. Object 4Fy7h: SRL (y+1) Set Input Off Percent 129
- 3.5.50. Object 4Fy8h: SRL (y+1) Reset Input Off Percent 129
- 3.5.51. Object 4Fy9h: SRL (y+1) Output PV..... 129
- 4. TECHNICAL SPECIFICATIONS..... 131**
 - 4.1. POWER SUPPLY 131**
 - 4.2. INPUTS..... 131**
 - 4.3. OUTPUT 131**
 - 4.4. COMMUNICATION..... 131**
 - 4.5. GENERAL SPECIFICATIONS 131**
- 5. VERSION HISTORY..... 133**

1. OVERVIEW OF CONTROLLER

1.1. Description of 4-Channel Strain Gauge Input Controller

This User Manual describes the architecture and functionality of the 4-Channel Strain Gauge input controller.

The 4-Channel Strain Gauge Input Controller (4CH-SG) is designed for versatile control of up to 4 input channels to measure strain gauge load cells independently, Digital input for Tare/Calibration operations, 1 Digital/Analog output and 1 Interlock/Relay output. The sophisticated control algorithms allow the user to program the controller for a wide range of applications without the need for custom software.

There are 4 strain gauge input channels which can be configured to read any type of Load Cell with output ranges from +/-19mV to +/-2.5V to suit a wide variety of applications.

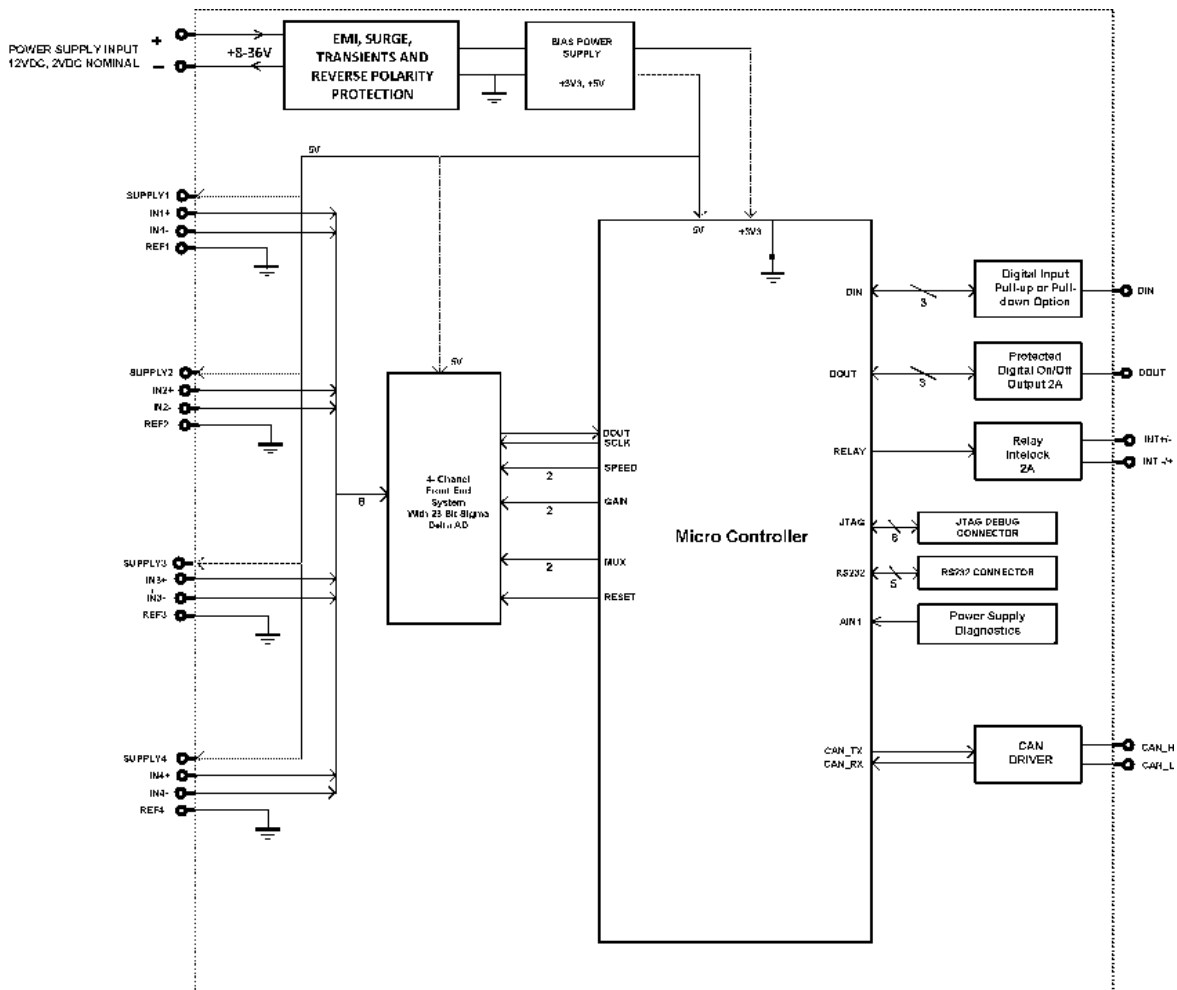

Figure 1 - Hardware Functional Block Diagram

The 4CH-SG is a highly configurable controller - allowing for custom configuration without the need for custom firmware. Its inputs, outputs, logical and mathematical function blocks allow its controller to support a wide variety of load cells, to fit various customer-specific applications, and can be integrated into a CANopen® network of controllers.

Each strain gauge input is periodically checked to see if its connection to the respective load cell has been disconnected or damaged. This process of checking for open wires is also configurable to suit various applications.

The 4CH-SG controller consists of a Digital Input, which is used for Tare/Calibration operations that are highly configurable, to accommodate various applications. In cases where the digital input is not desired to be used as a Tare, the controller also allows to Tare the inputs via CANopen® messages.

The controller also consists of an Interlock output and a Digital/Analog output. These can be used for signaling through an LED/lamp, driving an On/Off valve and/or as an interlock mechanism.

All inputs and logical function blocks on the unit are inherently independent from one another, but can be programmed to interact in a large number of ways. Figure 2 shows the hardware features of the 4CH-SG while Figure 1 shows the firmware features of the 4CH-SG.

The various function blocks supported by the 4CH-SG are outlined in the following sections. All objects are user configurable using standard commercially available tools that can interact with a CANopen® Object Dictionary via an .EDS file.

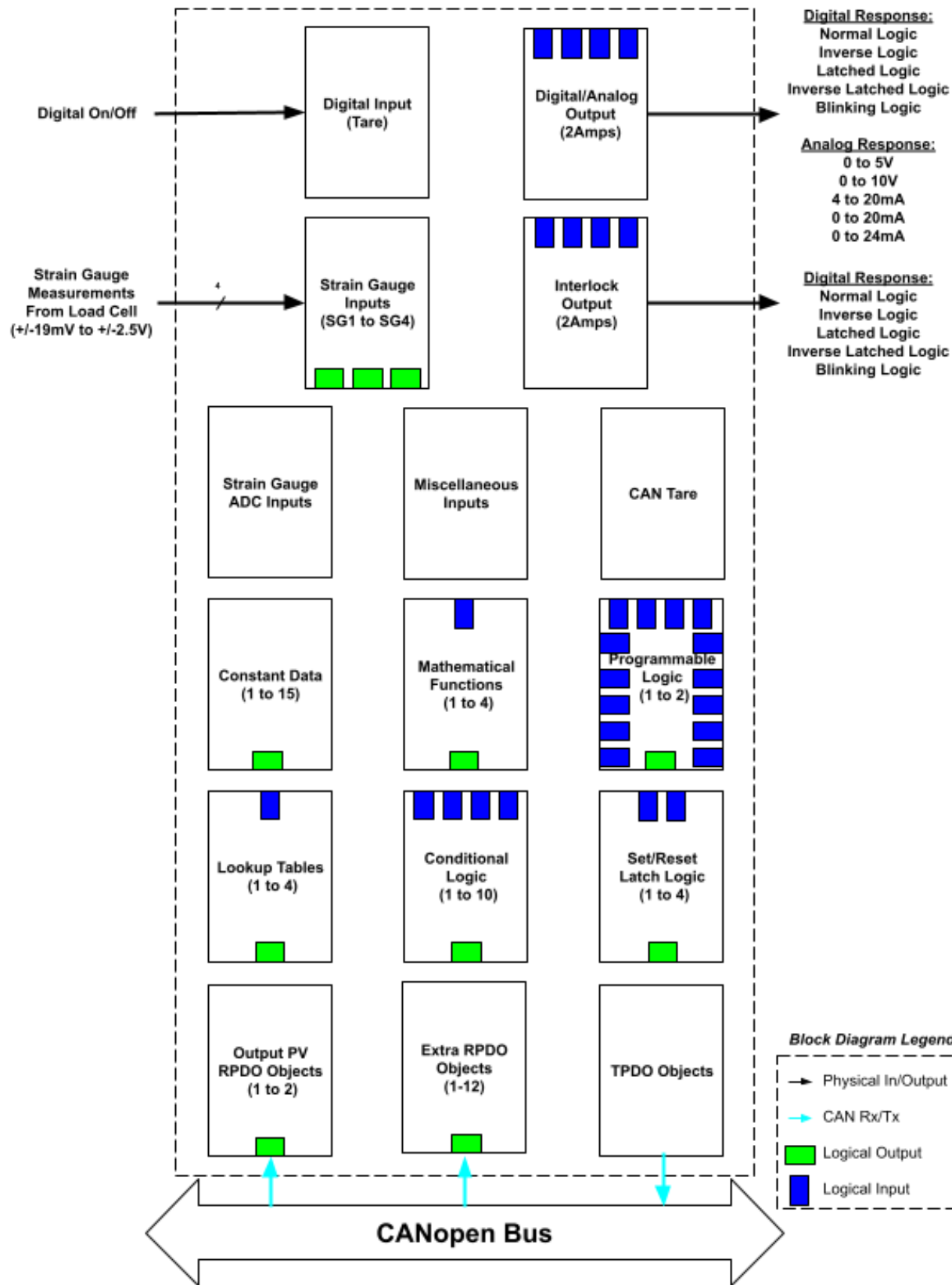

Figure 2 - Firmware Functional Block Diagram

1.2. Strain Gauge ADC Function Block

The Strain Gauge ADC (SGADC) function block is used to configure the general parameters of the Analog to Digital Converter which all strain gauge inputs are connected, and affecting how the data is read.

Object 2100h **SGADC Enable** is used to either enable or disable all conversions performed by the unit. While performing conversions there are several parameters that are used to influence how the data is processed and the effect of noise performance. Object 2101h **SGADC Digital Filter** can be adjusted to use a low-pass 'SINC N' filter (programmable N of 1 through 5) or a finite input response filter, 'FIR'. The finite response filter provides single-cycle settled data with simultaneous rejection of 50 and 60Hz frequencies. Object 2102h **SGADC Data Rate** can also be selected as various values in the range of 2.5 to 40,000 samples per second (SPS). Additionally, the gain can be adjusted through Object 2103h **SGADC Gain Select**, to values in the range of 1 to 128.

The final setting in this function block, the Object 2104h **SGADC Burnout Time** is used to configure the time period interval in between the unit entering its burnout mode to check for open wires across all strain gauge inputs. If this time is set to '0' no open wire checking will occur. Reducing this interval will have a negative effect on the accuracy of the conversions.

1.3. Strain Gauge Input Function Block

The Strain Gauge Input (SGIN) function block is the logic associated with measuring and managing strain gauge inputs. The SGIN function block provides configurable parameters.

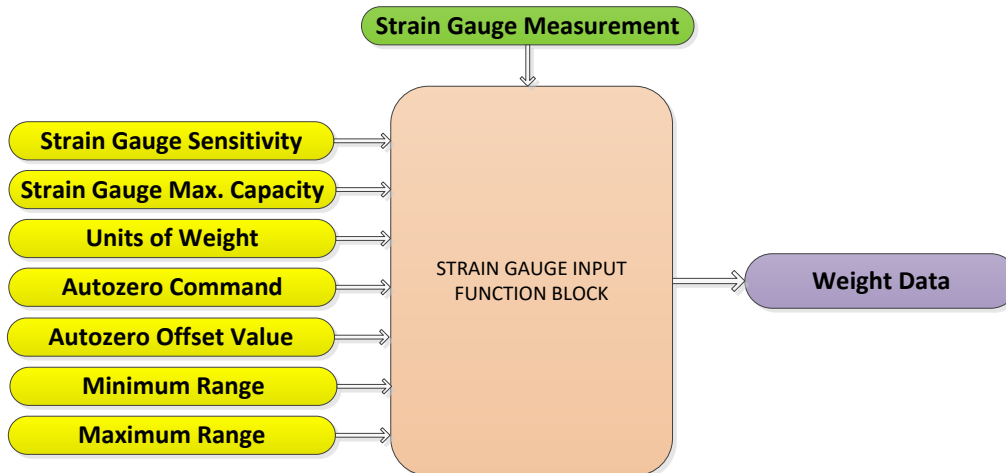

Figure 3 - Strain Gauge Input Function Block Diagram

Object 2114h **SGIN Sensitivity** is the Strain Gauge Load Cell's output voltage (in mV/V).

Object 2113h **SGIN Rated Weight** is the maximum weight (in kilograms) the strain gauge can sense. With these two parameters, the 4CH-SG controller will modify its input measurements to determine the appropriate calculations based on the load cell's entire output range.

When the required or desired measurements of weight need to be other than kg, object 2110h **SGIN Weight Units** can be used to convert the measured weight in kg (by default) into pounds (lbs). This conversion of weight can be used in other functional blocks to compare to different weights.

Value	Meaning
0	<i>Kilograms (kg)</i>
1	<i>Pounds (lbs)</i>

Table 1 - Weight Conversion Options

Strain gauge load cells typically have an offset when installing. There may be weight added to the load cells, i.e. a platform which exerts weight onto the strain gauges. These offsets or extra added weight may be desired to become to 'zero-weight' position of the system. The 4CH-SG controller is continuously reading input data from strain gauge load cells. Another alternative to using the Tare button as explained in section 1.2, when object 2111h **SGIN Auto Null** is set to TRUE, the current measured weight (in kg or lbs) by the 4CH-SG will be considered the 'zero-weight' position. By doing this, object 2112h **SGIN Auto Null Offset** will be automatically updated to the current weight position. Alternatively, the Auto Null Offset can be set at any time.

1.4. Tare/Calibration Input Function Block

The Tare/Calibration input function block can be used to zero the platform and measure and store minimum and maximum weights of the 4-strain gauge system. Figure 4 shows the parameters in the Tare Input Function Block:

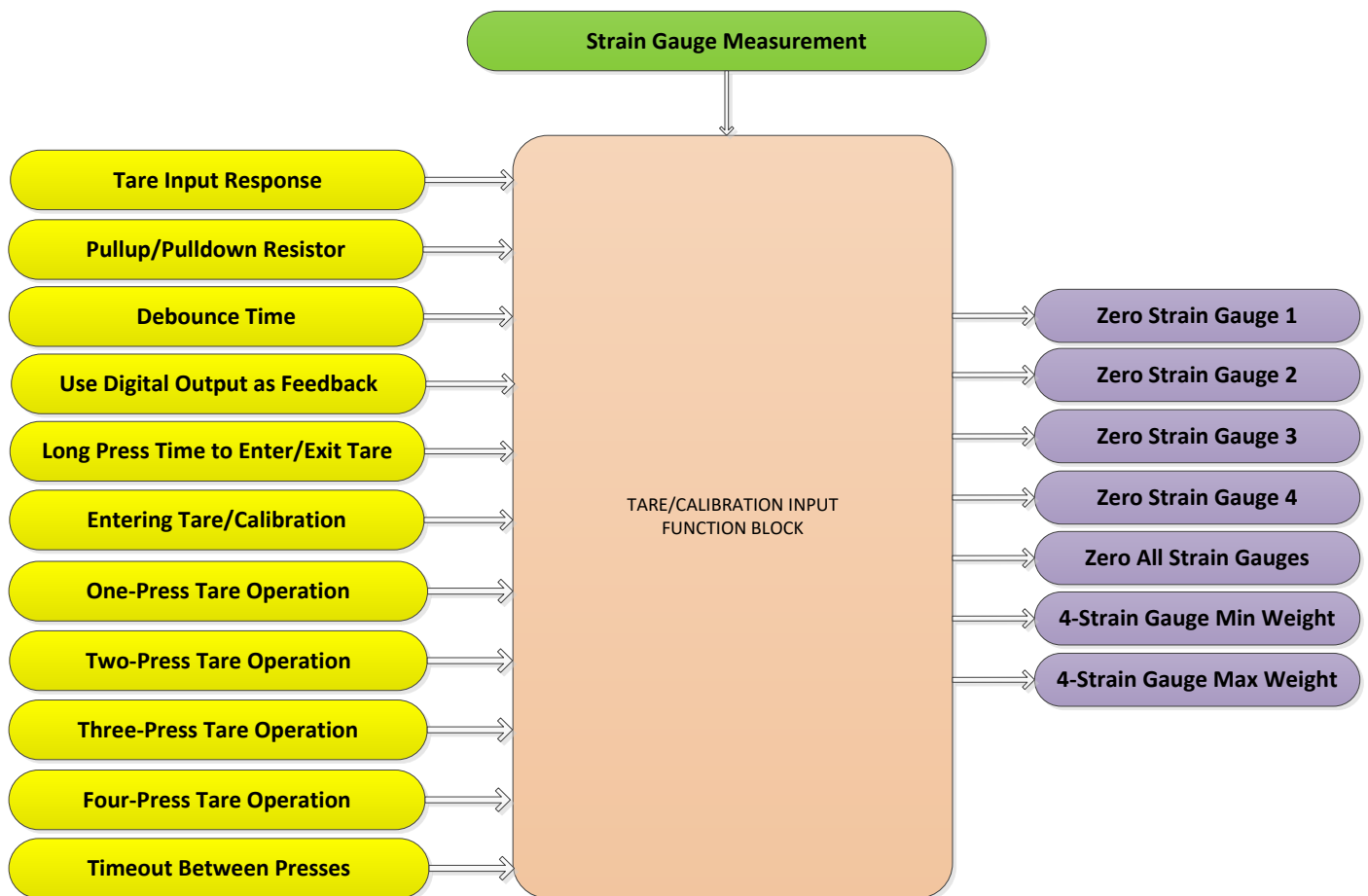

Figure 4 - Tare/Calibration Input Function Block Diagram

1.4.1. Digital Input Setpoints

Object 6030h **DI Polarity** allows the user to select how the controller responds to the behaviour of the digital input. The signals going into the controller are interpreted as 0 or 1. The turn ON value (1) is reached at ~1V signal. Table 2 shows the different Tare Input Responses with the default response being highlighted.

Value	Meaning
0	Normal On/Off
1	Inverse Logic
2	Latched Logic

Table 2 - Tare Input Response

22kOhm pull-up and 22kOhm pull-down resistors can be enabled or both can be disabled using the object 2020h **DI Pull Up/Down Mode**. Table 3 lists the available pull-up/pull-down resistor options with the default option highlighter.

Value	Meaning
0	Pullup/Pulldown Off
1	22kOhm pullup
2	22kOhm pulldown

Table 3 - Pull-up/Pull-down Resistor Options

The Debounce Time parameter is a useful parameter in cases where the digital input signal coming into the controller is noisy. Figure 5 how the Debounce Time helps detect a correct input signal

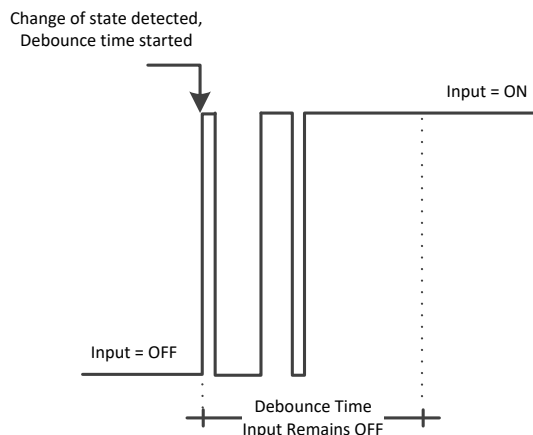

Figure 5 - Digital Input Debounce Time

1.4.2. Tare/Calibrate Functionality

When calibrating or zeroing the strain gauge inputs, the 4CH-SG offers a variety of options that can be performed with the use of a single Tare button. Object 2040h **DI Digital Output Feedback** gives the user the option of using one of the digital outputs as feedback to calibration steps. Table 4 lists the different feedback types that can be selected when Tare/Calibrating.

Value	Meaning
0	No Feedback Used
1	Digital Output

When using the Digital Output or the Interlock Output as feedback when calibrating, the following scenarios will occur:

- Outputs will not be commanded by their respective control sources
- The selected output will engage for 750ms when Entering Calibration
- The selected output will engage for 250ms corresponding to the Tare Operation number
- The selected output will engage for 750ms when Exiting Calibration
- Outputs will be commanded by their respective control sources after exiting calibration

1.4.2.1. Entering/Exiting Calibration

In order to prevent 'false calibration' by pressing the Tare button by mistake, it is therefore necessary to enter calibration mode and exit calibration mode. Object 2050h **DI Long Press Time** is used to accomplish this function. Figure 6 explains the operation of entering and exiting calibration mode.

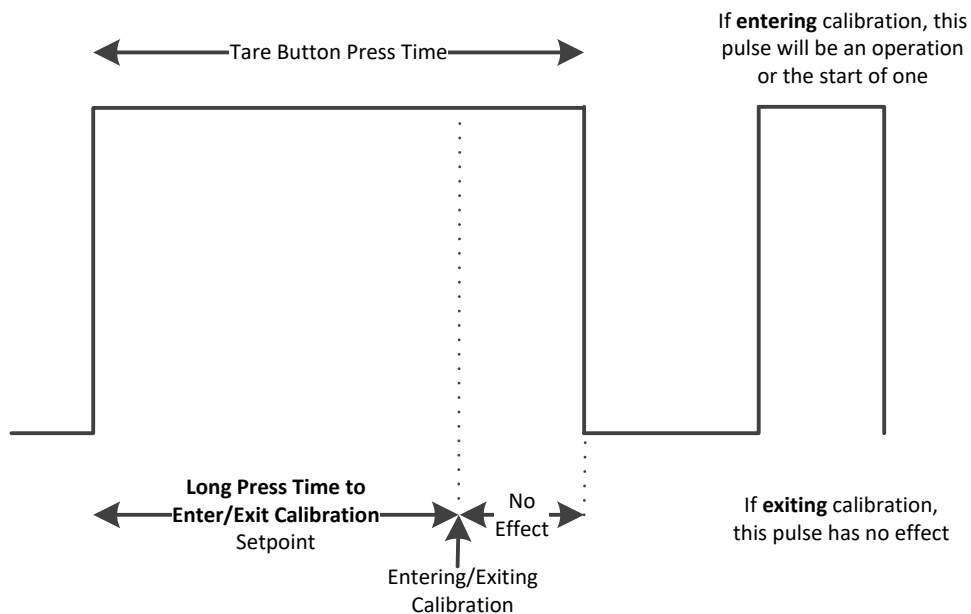

Figure 6 - Long Press to Enter/Exit Calibration Mode

As shown in Figure 6, the user can press the Tare button for much longer than the **DI Long Press Time** as it will have no effect on the calibration. When entering calibration, any Tare button press which has been pressed for shorter period of time than **DI Long Press Time** object will be considered a Tare/Calibration operation. Refer to Section 1.4.2.2 for more details. On the other hand, when exiting calibration, any Tare button press which has been pressed for shorter period of time than **DI Long Press Time** will be ignored.



It is very important to exit calibration after the needed operations have been completed. Otherwise, the tare/calibration operations will not be saved.

1.4.2.2. Tare/Calibration Operations

After entering calibration mode the amount of consecutive presses will reflect the operation number. Consecutive presses are determined by object 20A0h **DI Time Between Presses**. As long as the next Tare button press occurs before this parameter, the number of consecutive presses increases. Once the timeout occurs, the operation that will be executed will be determined by the count of consecutive presses before the timeout happened. Figure 7 provides a graphical explanation.

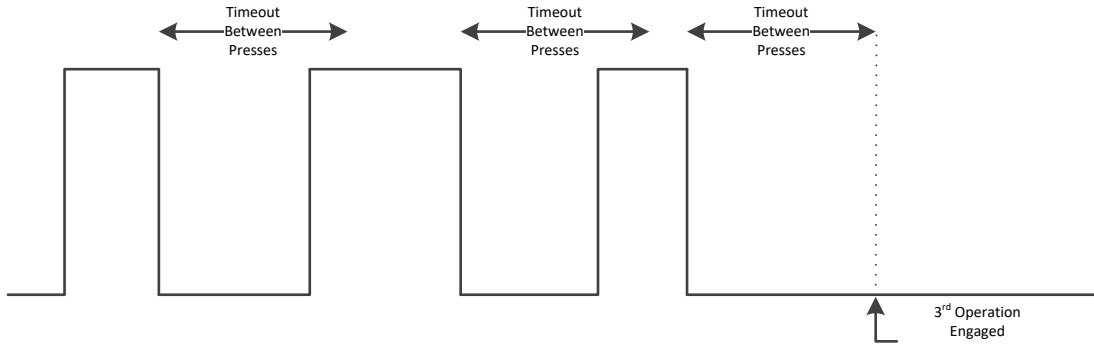

Figure 7 - Timeout Between Presses (Example)

The 4CH-SG allows up to 4 Tare/calibration operations that the user can perform. Table 5 lists all the available operations. Objects 2060h **DI One Press Operation**, 2070h **DI Two Press Operation**, 2080h **DI Three Press Operation**, and 2090h **DI Four Press Operation** determine what operation is used for each sequence of presses.

Value	Tare Operation
0	Operation Not Used
1	Zero Strain Gauge 1
2	Zero Strain Gauge 2
3	Zero Strain Gauge 3
4	Zero Strain Gauge 4
5	Zero All Strain Gauges
6	Set Overall Minimum Weight
7	Set Overall Maximum Weight

Table 5 - Tare Operations

When Tare Options 6 and 7 are used ('Set Overall Minimum Weight' and 'Set Overall Maximum Weight') as Tare/Calibration steps, their results - after exiting calibration mode - will be stored to Constant Data List 1 and Constant Data List 2, respectively. This allows the user to use those variables as inputs to other function blocks.

1.5. Internal Function Block Control Sources

The 4-Channel Strain Gauge controller allows for internal function block sources to be selected from the list of the logical function blocks supported by the controller. As a result, any output from one function block can be selected as the control source for another. Keep in mind that not all options make sense in all cases, but the complete list of control sources and their respective ranges is shown in Table 6.

Value	Meaning	Source Range
0	Control Not Used	[0]
1	Strain Gauge Input Raw Data	[1...4]
2	Strain Gauge Input mV Data	[1...4]
3	Strain Gauge Input Weight Data	[1...4]
4	CAN Tare Message	[1]
5	CAN Receive Message	[1...5]
6	Constant Data	[1...15]
7	Math Block	[1...4]
8	Programmable Logic Block	[1...2]
9	Lookup Table	[1...6]
10	Conditional Logic Block	[1...10]
11	Set-Reset Latch	[1...3]

Table 6 - Control Source Options

1.6. Digital / Analog & Interlock Outputs Function Blocks

The 4CH-SG supports a Digital/Analog Output as well as an Interlock Output. These outputs can be used for signaling, driving on/off valves, and interlocking – whichever the application may be. The Digital/Analog Output is capable of being configured as either a digital or analog output, but not both simultaneously.

The Digital and Interlock Outputs function similarly, but the Digital/Analog function block has additional parameters to select and control the output in Analog mode. The object 2200h **AO DO Output Type** setting is used to determine whether the output is disabled or transmitted as a digital or analog output, as listed in Table 7.

Value	Meaning
0	Output Disabled
1	Digital Output
2	Voltage Output
3	Current Output

Table 7 - Digital/Analog Output Types

As an analog output, the additional objects 2320h **AO Output Range**, 2321h **AO Slew Rate Control**, 2322h **AO Slew Rate Step Options**, and 2323h **AO Slew Rate Clock Options** are used to configure the output. The **AO Output Range** values change according to the output type selected, as shown in Table 8.

Value	Meaning	
	Voltage Output	Current Output
0	0 to 5 V	4 to 20 mA
1	0 to 10 V	0 to 20 mA
2	-	0 to 24 mA

Table 8 - Analog Output Ranges

If **AO Slew Rate Control** is enabled, then the Step and Clock Options are used to program the slew rate of the output as shown in Table 9 and Table 10. While in an analog mode, the output is

only controlled by object 2210h **AO DO Control Source** and object 2211h **AO DO Control Number**, and scaled according to the settings of the input selected and the output range chosen.

Value	Meaning
0	0.0625
1	0.125
2	0.5
3	1
4	2
5	4
6	8

Table 9 - Slew Rate Step Options

Value	Meaning
0	258,065 Hz
1	200,000 Hz
2	153,845 Hz
3	131,145 Hz
4	115,940 Hz
5	69,565 Hz
6	37,560 Hz
7	25,805 Hz
8	20,150 Hz
9	16,030 Hz
10	10,295 Hz
11	8,280 Hz
12	6,900 Hz
13	5,530 Hz
14	4,240 Hz
15	3,300 Hz

Table 10 - Slew Rate Clock Options

The Digital and Interlock Outputs use various control sources to drive the output, each available from the listed sources in **Error! Reference source not found.** The Digital Output will be controlled by these sources in the following order: object 2260h **DO Override Source**, object 2250h **DO Enable Source**, object 2210h **DO Control Source**, object 2270h **DO Unlatch Source**. While the Interlock/Relay output will be controlled by these sources in the following order: object 2430h **RLY Override Source**, object 2420h **RLY Enable Source**, object 2410h **RLY Control Source**, object 2440h **RLY Unlatch Source**. Each output must have at least the control source active to be functional.

The following sub sections will explain in more detail the functionalities and available setpoints/parameters. The corresponding Interlock output objects will be included in brackets where applicable.

1.6.1. Output Override

The object 2260h **DO Override Source** (object 2430h **RLY Override Source**) will determine whether or not the output will be commanded by the **AO DO Control Source** (object 2410h **RLY Control Source**). This Source has a higher priority than the Enable Source.

There are two different Override Responses in which the Override signal can be used. These responses are listed in Table 11, where the default value is highlighted.

Value	Meaning
0	Override When OFF
1	Override When ON

Table 11 - Override Responses

When object 2262h **DO Override Response** (object 2232h **RLY Override Response**) is configured to *Override When ON*, the output will be commanded according to the signal of the Control Source/Number by object 2263h **DO Override State** (object 2233h **RLY Override State**). If the Override Response is set to *Override When OFF*, the relay output will be commanded according to the signal of the Control Source/Number by the Override State. Table 12 shows the two possible states for the Override Response.

Value	Meaning
0	Override State OFF
1	Override State ON

Table 12 - Override States

In case of '*Override State OFF*', the output switches to Normally Open. If '*Override State ON*' is configured, the output changes to Normally closed.

1.6.2. Output Enable

The object 2250h **DO Enable Source** (object 2420h **RLY Enable Source**) will determine whether or not the output will be commanded by the Control Source. There are six different Enable Responses in which the enable signal can be used. These responses are listed in Table 13, where the default value is highlighted.

Value	Meaning
0	Enable When ON
1	Enable When OFF
2	Disable When ON
3	Disable When OFF
4	Enable When ON Else Keep State
5	Enable When OFF Else Keep State

Table 13 - Enable Responses

When object 2252h **DO Enable Response** (object 2422h **RLY Enable Response**) is set to '*Enable When ON*' or '*Disable When OFF*', the output will be commanded according to the signal of the Control Source/Number and object 2230h **DO Logic Type** (object 2401h **RLY Logic Type**) only when the signal of the Enable Source/Number is ON. Otherwise, the output is commanded to the OFF state.

Similarly, when the Enable Response is set to '*Enable When OFF*' or '*Disable When ON*', the output will be commanded according to the Control Source/Number and the Logic Type only when the signal of the Enable Source/Number is OFF. Otherwise, the output is commanded to the OFF state.

In case the Enable Response is '*Enable When ON Else Keep State*', the relay output will be commanded according to the signal of the Control Source/Number and the Logic Type only when the signal of the Enable Source/Number is ON. If the Enable Source is OFF, the output will keep the previous state.

Likewise, when the Enable Response is configured to '*Enable When OFF Else Keep State*', the output will be commanded according to the Control Source/Number and the Logic Type only when the Enable Source/Number is OFF. Otherwise, the output holds the previous state.

A time delay for both states (ON, OFF) can be set by setting object 2253h **DO Enable Response Delay** (object 2423 **RLY Enable Response Delay**) to true. The values of these time delays can be set with the objects 2235h **DO Off State Delay** and 2236h **DO On State Delay** (objects 2405h **RLY Off State Delay** and 2406h **RLY On State Delay**). In this case, the delays are valid for the enable state and the control state.

1.6.3. Output Control

When the output is being commanded by the Control Source/Number, the selected object 2230h **DO Logic Type** (object 2401h **RLY Logic Type**) determines what logic is used.

The Logic Type allows for flexibility in the response of the output. Table 14 shows the options available for this parameter.

Value	Meaning
0	Output Not Implemented
1	Normal Logic
2	Inverse Logic
3	Latched Logic
4	Inverse Latched Logic
5	Toggle Logic

Table 14 - Logic Types

By default, '*Normal Logic*' response is used for the outputs.

In a '*Normal Logic*' response, if the source of the respective output is triggered ON, the output state will be ON.

In the case of an '*Inverse Logic*' response, when the source of the respective relay output is triggered OFF, the output state will be ON.

In the case of a '*Latched Logic*' response, every time the source of the respective output goes from OFF to ON, the output state will turn ON. The opposite behavior applies for the '*Inverse Latched Logic*'. If the output switches from ON to OFF, the output state changes.

The '*Toggle Logic*' lets the output toggle for a configured frequency. The time period for switching from one state to the other state is determined by the object 2231h **DO Toggle Frequency** (object 2401h **RLY Toggle Frequency**) which is in milliseconds and by default 0ms.

1.6.4. Output Unlatch

This source can only be configured if object 2230h **DO Logic Type** (object 2401h **RLY Logic Type**) is set to '*Latched Logic*' or '*Inverse Latched Logic*'. If the state of the Unlatch Source/Number signal is normally closed, it turns the output state OFF in case the Logic Type is set to '*Latched Logic*'. If the Unlatch Source/Number signal state turns normally open afterwards, the output state stays OFF independent of the Output state before. The reverse behavior is valid for the '*Inverse Latched Logic*'.

1.7. Miscellaneous Function Block

Extra RPDO Messages

Objects 2500h **Extra Control Received PV**, 2502h **EC Decimal Digits PV**, 2502h **EC Scaling 1 PV** and **EC Scaling 2 PV** allow for additional data received on a CANopen® RPDO to be mapped independently to various function blocks as a control source. The scaling objects are provided to define the limits of the data when it is used by another function block, as shown in **Error! Reference source not found.**

Constant Values

Object 5010h **Constant Field Value** is provided to give the user the option for a fixed value that can be used by other function blocks. Sub-index 1 is fixed as FALSE (0) and sub-index 2 is always TRUE (1). There are 13 other sub-indexes provided for user selectable values.

The constants are read as 32-bit real (float) data, so no decimal digit object is provided. When setting up the constant, make sure to do it with the resolution of the object that will be compared with it.

The False/True constants are provided primarily to be used with the logic block. The variable constants are also useful with the logic or math blocks.

Fault Detection Objects

For the AX200301 controller to begin monitoring fault detections, object 5050h **Error Check Detection** determines which Fault Detection is enabled through 1 byte data as bits. Once a fault is detected, object 5051h **Error Response Delay** will determine how long (in 100ms steps) the fault needs to be present to flag and error.

Startup

The last object 5555h **Start in Operational** is provided as a 'cheat' when the unit is not intended to work with a CANopen® network (i.e. a stand-alone control), or is working on a network comprised solely as slaves so the OPERATION command will never be received from a master. By default, this object is disabled (FALSE).

When using the AX200301 as a stand-alone controller where 5555h is set to TRUE, it is recommended to disable all TPDOs (set the Event Timer to zero) so that it does not run with a continuous CAN error when not connected to a bus.

1.8. CAN Tare Function Block

The CAN Tare function block is a means to zero/tare the input via CAN RPDO messages. To tare the inputs via this function block the user must send the specific CAN message frames the 4CH-SG expects. By default, RPDO 3 is mapped to fill object 2600h **CAN Tare**.

The message to be sent is a 2-byte message with the first byte being the command while the second byte determines the operation. See the below tables for the list of commands and operations.

Command	First Byte Data
Enter Calibration	0xAB
Exit Calibration and Save	0xBA

Table 15 - CAN Tare Command Byte

Options	Bits on Second Byte Data
Tare Strain Gauge Input 1	1 st bit location
Tare Strain Gauge Input 2	2 nd bit location
Tare Strain Gauge Input 3	3 rd bit location
Tare Strain Gauge Input 4	4 th bit location
Minimum Sum of all Strain Gauge Inputs is saved as a Constant in Constant Data List	5 th bit location
Maximum Sum of all Strain Gauge Inputs is saved as a Constant in Constant Data List	6 th bit location

Table 16 - CAN Tare Option Byte

For example, if Strain Gauge Inputs 1 & 3 need to be Tared, the following command would be sent to the 4CH-SG unit (with the default settings)

ID	Length	D0	D1
0x57F	2	0xAB	0x05 (00000101b)

Then to save the calibration settings to the flash, the following command needs to be sent:

PGN	Length	D0	D1
0x57F	2	0xBA	0xnn

D1: 0xnn (this byte is ignored when 0xBA is sent)

1.9. Lookup Table Function Block

Lookup Tables are used to give an output response of up to 10 slopes per input. The array size of the Response [], Point X [] and Point Y [] setpoints shown in the block diagram above is therefore 6.

Note: If more than 10 slopes are required, a Programmable Logic Block can be used to combine up to three tables to get 30 slopes.

There are two key setpoints that will affect this function block. The first is the object 30y0h **Lookup Table y X-Axis Source** and object 30y1h **Lookup Table y X-Axis Number** which together define the Control Source for the function block. When it is changed, the table is automatically updated with new defaults based on the X-Axis source selected if object 30y2h **Lookup Table y Auto Repeat** is *TRUE*.

As stated earlier if Auto Repeat is *TRUE*, should the selected Control Source change (i.e. the Min or Max values of the function block are updated), the associated table will also be automatically updated with default settings, based on the new X-Axis limits.



Initialize the Control Source of a Lookup Table BEFORE changing the table values, as the new settings WILL get erased when the control is updated if the **Auto Repeat** in the Miscellaneous function block is set to *TRUE*.

The second setpoint that will affect the function block (i.e. reset to defaults), is object 30y9h **Lookup Table y X-Axis Type**. By default, the tables have a '*Data Response*' output. Alternatively, it can be selected as a '*Time Response*'.

1.9.1. X-Axis, Input Data Response

In the case where the X-Axis Type = '*Data Response*', the points on the X-Axis represents the data of the control source. These values must be selected within the range of the control source.

When selecting X-Axis data values, there are no constraints on the value that can be entered into any of the X-Axis points. The user should enter values in increasing order to be able to utilize the entire table. Therefore, when adjusting the X-Axis data, it is recommended that X₁₀ is changed first, then lower indexes in descending order as to maintain the below:

$$\text{MinInputRange} \leq X_0 \leq X_1 \leq X_2 \leq X_3 \leq X_4 \leq X_5 \leq X_6 \leq X_7 \leq X_8 \leq X_9 \leq X_{10} \leq \text{MaxInputRange}$$

As stated earlier, MinInputRange and MaxInputRange will be determined by the X-Axis Source that has been selected.

If some of the data points are '*Ignored*' as described in Section 1.9.4, they will not be used in the X-Axis calculation shown above. For example, if points X₄ and higher are ignored, the formula becomes MinInputRange \leq X₀ \leq X₁ \leq X₂ \leq X₃ \leq MaxInputRange instead.

1.9.2. Y-Axis, Lookup Table Output

The Y-Axis has no constraints on the data that it represents. This means that inverse, or increasing/decreasing or other responses can be easily established.

In all cases, the controller looks at the entire range of the data in the Y-Axis setpoints, and selects the lowest value as the MinOutRange and the highest value as the MaxOutRange. They are passed directly to other function blocks as the limits on the Lookup Table output. (i.e. used as Xmin and Xmax values in linear calculations.)

However, if some of the data points are '*Ignored*' as described in Section 1.9.4, they will not be used in the Y-Axis range determination. Only the Y-Axis values shown on the Axiomatic EA will be considered when establishing the limits of the table when it is used to drive another function block, such as a Math Function Block.

1.9.3. Default Configuration, Data Response

By default, all Lookup Tables in the ECU are disabled (X-Axis Source equals '*Control Source Not Used*'). Lookup Tables can be used to create the desired response profiles. If a Strain Gauge input is used as the X-Axis, the output of the Lookup Table will be what the user enters in Y-Axis[] setpoints.

Recall, any controlled function block which uses the Lookup Table as an input source will also apply a linearization to the data. Therefore, for a 1:1 control response, ensure that the minimum and maximum values of the output correspond to the minimum and maximum values of the table's Y-Axis.

All tables (1 to 4) are disabled by default (no control source selected). However, should an X-Axis Source be selected, the Y-Axis defaults will be in the range of 0 to 100% as described in the "Y-Axis, Lookup Table Output" section above. X-Axis minimum and maximum defaults will be set as described in the "X-Axis, Data Response" section above.

By default, the X-Axis and Y-Axis data is setup for an equal value between each point from the minimum to maximum in each case.

1.9.4. Point To Point Response

By default, the X and Y axes are setup for a linear response from point (0,0) to (10,10), where the output will use linearization between each point, as shown in Figure 8. For a smooth linear response, each point in the 30z5h **LTz Point Response** array is setup for a 'Ramp To' output.

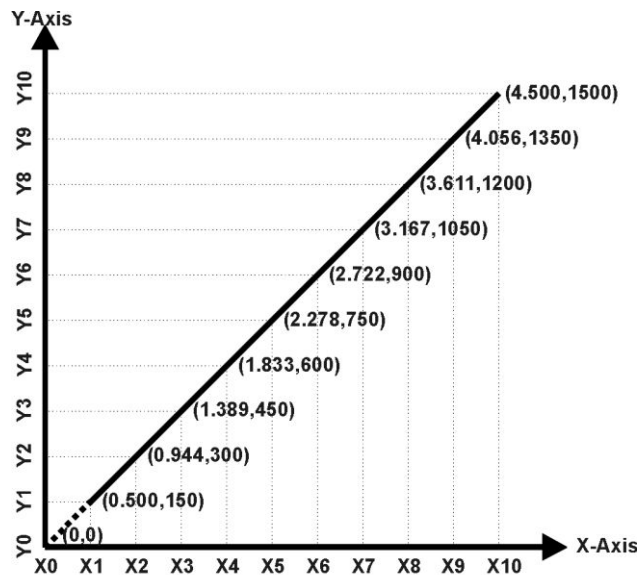
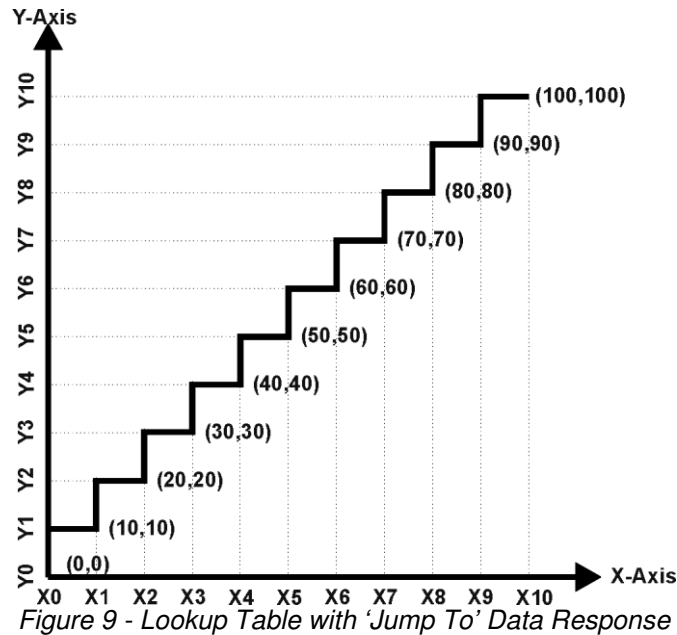

Figure 8 - Lookup Table with "Ramp To" Data Response

Alternatively, the user could select a 'Jump To' response for **Point N – Response**, where N = 1 to 10. In this case, any input value between X_{N-1} to X_N will result in an output from the Lookup Table function block of Y_N.

An example of a Math function block (0 to 100) used to control a default table (0 to 100) but with a 'Jump To' response instead of the default 'Ramp To' is shown in Figure 9.



Lastly, any point except (0,0) can be selected for an 'Ignore' response. If **Point N – Response** is set to ignore, then all points from (X_N, Y_N) to (X₅, Y₅) will also be ignored. For all data greater than X_{N-1}, the output from the Lookup Table function block will be Y_{N-1}.

A combination of 'Ramp To', 'Jump To' and 'Ignore' responses can be used to create an application specific output profile.

1.9.5. X-Axis, Time Response

A lookup table can also be used to get a custom output response where the "X-Axis Type" is a 'Time Response'. When this is selected, the X-Axis now represents time, in units of milliseconds, while the Y-Axis still represents the output of the function block.

With this response, the sequence will start depending on two parameters:

- **Lookup Table yz Input X-Axis Source** Object 3yz0h and;
- **Lookup Table yz Auto Repeat** Object 3yz2h

By default, the "Auto Repeat" object is set to FALSE (0). In this case, the lookup table will react in the following way:

The X-Axis control source is treated as a digital input. When the control input is ON, the output will be changed over a period of time based on the profile in the lookup table. Once the profile has finished (i.e. reached index 11, or an 'Ignored' response), the output will remain at the last output at the end of the profile until the control input turns OFF.

However, when the "Auto Repeat" object is set to TRUE (1), the lookup table will react in the following way:

When the control input is ON, the output will be changed over a period of time based on the profile in the lookup table. Once the profile has finished (i.e. reached index 11, or an 'Ignored' response), the lookup table will revert back to the first point in the table and Auto

Repeat the sequence. This will continue for as long as the input remains ON. Once the input turns OFF, the lookup table sequence will stop and the output of the lookup table is zero.

Note: When the control input is OFF, the output is always at zero. When the input comes ON, the profile will **ALWAYS** start at position (X₁, Y₁) which is 0 output for 0ms.

When using the lookup table to drive an output based on **time**, it is mandatory that objects 2330h **Ramp Up** and 2331h **Ramp Down** in the analog output function block be set to **zero**. Otherwise, the output result will not match the profile as expected. Recall, also, that the AO scaling should be set to match the Y-Axis scaling of the table in order to get a 1:1 response of AO Output FV versus LTyz Output Y-Axis PV.

In a time response, the data in object 30z6h **LTyz Point X-Axis PV** is measured in milliseconds, and object 3yz3h **LTyz X-Axis Decimal Digits PV** is automatically set to 0. A minimum value of 1ms must be selected for all points other than sub-index 1 which is automatically set to [0,0]. The interval time between each point on the X-axis can be set anywhere from 1ms to 24 hours. [86,400,000 ms]

1.10. Programmable Logic Function Blocks

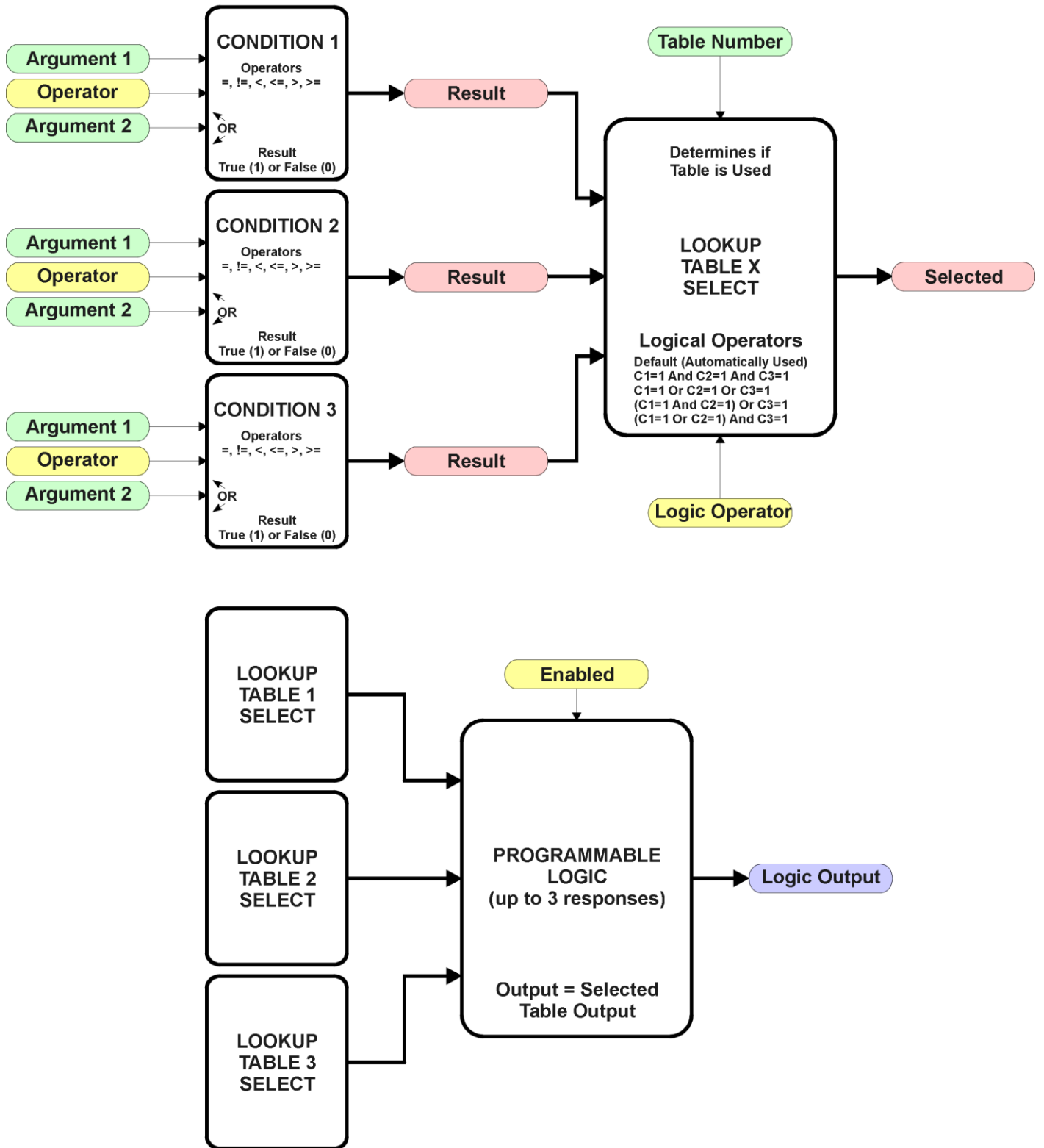

Figure 10 - Programmable Logic Function Block

This function block is obviously the most complicated of them all, but very powerful. The Programmable Logic can be linked to up to three tables, any one of which would be selected only under given conditions. Any three tables (of the available 8) can be associated with the logic, and which ones are used is fully configurable.

Should the conditions be such that a particular table (1, 2 or 3) has been selected as described in Section 1.10.2, then the output from the selected table, at any given time, will be passed directly to the Logic Output.

Therefore, up to three different responses to the same input, or three different responses to different inputs, can become the input to another function block, such as an Output X Drive. To do this, the **Control Source** for the reactive block would be selected to be the '*Programmable Logic Function Block*.'

In order to enable any one of Programmable Logic blocks, the **Programmable Logic Block Enabled** setpoint must be set to True. They are all disabled by default.

Logic is evaluated in the order shown in Figure 11. Only if a lower number table has not been selected will the conditions for the next table be looked at. The default table is always selected as soon as it is evaluated. It is therefore required that the default table always be the highest number in any configuration.

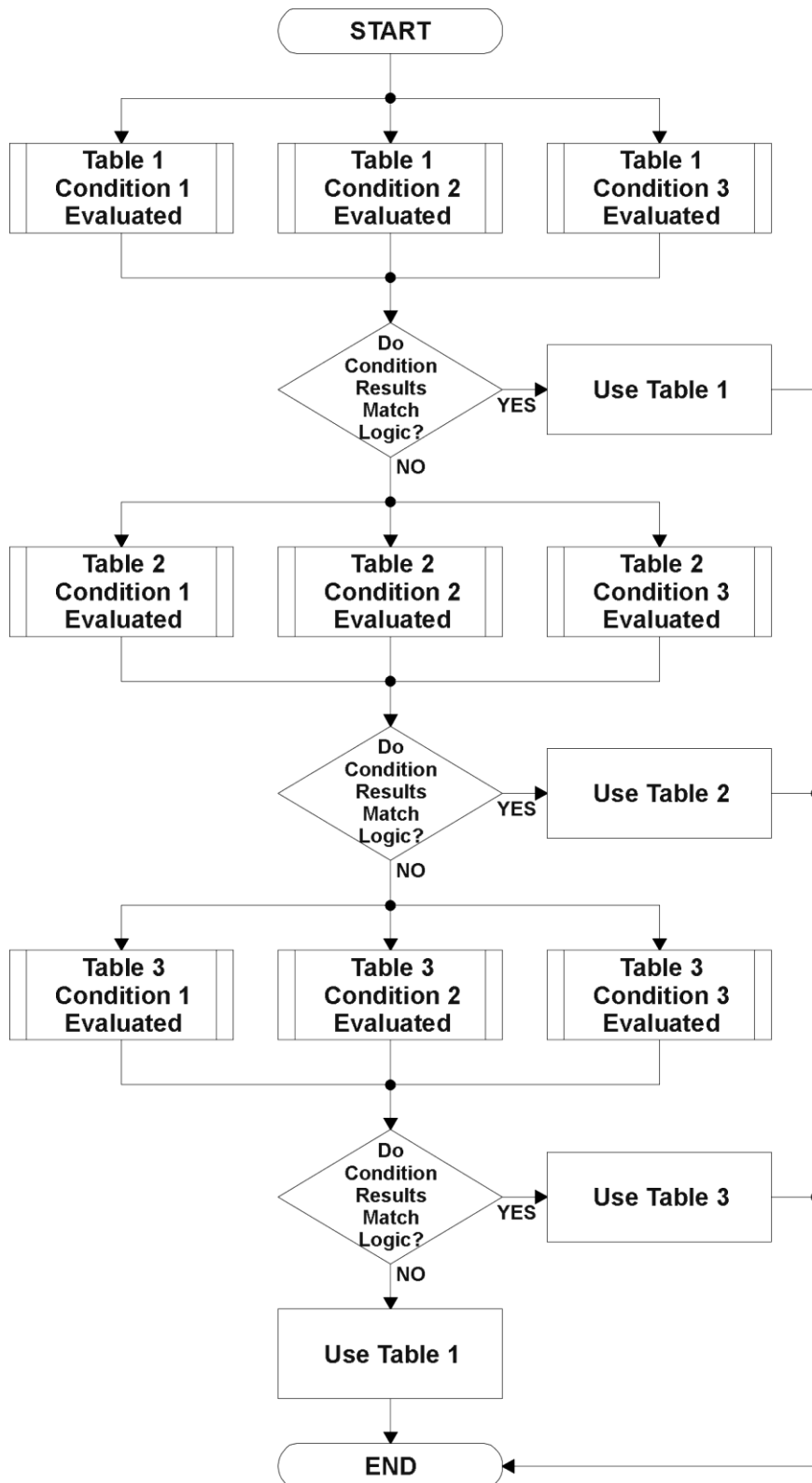

Figure 11 - Programmable Logic Flowchart

1.10.1. Conditions Evaluation

The first step in determining which table will be selected as the active table is to first evaluate the conditions associated with a given table. Each table has associated with it up to three conditions that can be evaluated.

Argument 1 is always a logical output from another function block, as listed in Section 1.5. As always, the source is a combination of the functional block type and number, setpoints **Table X, Condition Y, Argument 1 Source** and **Table X, Condition Y, Argument 1 Number**, where both X = 1 to 3 and Y = 1 to 3.

Argument 2 on the other hand, could either be another logical output such as with Argument 1, OR a constant value set by the user. To use a constant as the second argument in the operation, set **Table X, Condition Y, Argument 2 Source** to *'Control Constant Data.'* Note that the constant value has no unit associated with it in the Axiomatic EA, so the user must set it as needed for the application.

The condition is evaluated based on the **Table X, Condition Y Operator** selected by the user. It is always *'=, Equal'* by default. The only way to change this is to have two valid arguments selected for any given condition. Options for the operator are listed in Table 17.

0	=, Equal
1	!=, Not Equal
2	>, Greater Than
3	>=, Greater Than or Equal
4	<, Less Than
5	<=, Less Than or Equal

Table 17 - Condition Operator Options

For example, a condition for a weight going over a certain range could be that the Strain Gauge Input Measured 1 be greater than a certain value to flag a different output. In this case, **...Argument 1 Source** would be set to *'Strain Gauge Input Measured 1,* **“...Argument 2 Source”** to *'Control Constant Data,'* and the **...Operator** to *'>, Greater Than.'* The **Constant Value X** in the Constant Data List would be set to whatever warning weight the application required.

By default, both arguments are set to *'Control Source Not Used'* which disables the condition, and automatically results in a value of N/A as the result. Although Figure 11 shows only True or False as a result of a condition evaluation, the reality is that there could be four possible results, as described in Table 18.

Value	Meaning	Reason
0	False	(Argument 1) Operator (Argument 2) = False
1	True	(Argument 1) Operator (Argument 2) = True
2	Error	Argument 1 or 2 output was reported as being in an error state
3	Not Applicable	Argument 1 or 2 is not available (i.e. set to <i>'Control Source Not Used'</i>)

Table 18 - Condition Evaluation Results

1.10.2. Table Selection

In order to determine if a particular table will be selected, logical operations are performed on the results of the conditions as determined by the logic in Section 1.10.1. There are several logical combinations that can be selected, as listed in Table 19.

0	Default Table
1	Cnd1 And Cnd2 And Cnd3
2	Cnd1 Or Cnd2 Or Cnd3
3	(Cnd1 And Cnd2) Or Cnd3
4	(Cnd1 Or Cnd2) And Cnd3

Table 19 - Conditions Logical Operator Options

Not every evaluation is going to need all three conditions. The case given in the earlier section, for example, only has one condition listed, i.e. that the Engine RPM be below a certain value. Therefore, it is important to understand how the logical operators would evaluate an Error or N/A result for a condition.

Logical Operator	Select Conditions Criteria
Default Table	Associated table is automatically selected as soon as it is evaluated.
Cnd1 And Cnd2 And Cnd3	Should be used when two or three conditions are relevant, and all must be true to select the table. If any condition equals False or Error, the table is not selected. An N/A is treated like a True. If all three conditions are True (or N/A), the table is selected. If((Cnd1==True) &&(Cnd2==True)&&(Cnd3==True)) Then Use Table
Cnd1 Or Cnd2 Or Cnd3	Should be used when only one condition is relevant. Can also be used with two or three relevant conditions. If any condition is evaluated as True, the table is selected. Error or N/A results are treated as False If((Cnd1==True) (Cnd2==True) (Cnd3==True)) Then Use Table
(Cnd1 And Cnd2) Or Cnd3	To be used only when all three conditions are relevant. If both Condition 1 and Condition 2 are True, OR Condition 3 is True, the table is selected. Error or N/A results are treated as False If(((Cnd1==True)&&(Cnd2==True)) (Cnd3==True)) Then Use Table
(Cnd1 Or Cnd2) And Cnd3	To be used only when all three conditions are relevant. If Condition 1 And Condition 3 are True, OR Condition 2 And Condition 3 are True, the table is selected. Error or N/A results are treated as False If(((Cnd1==True) ((Cnd2==True) && (Cnd3==True)) Then Use Table

Table 20 - Conditions Evaluation Based on Selected Logical Operator

The default **Table X, Conditions Logical Operator** for Table 1 and Table 2 is 'Cnd1 And Cnd2 And Cnd3,' while Table 3 is set to be the 'Default Table.'

1.10.3. Logic Block Output

Recall that Table X, where X = 1 to 3 in the Programmable Logic function block does NOT mean Lookup Table 1 to 3. Each table has a setpoint **Table X – Lookup Table Block Number** which allows the user to select which Lookup Tables they want associated with a particular Programmable Logic Block. The default tables associated with each logic block are listed in Table 21

Programmable Logic Block Number	Table 1 – Lookup Table Block Number	Table 2 – Lookup Table Block Number	Table 3 – Lookup Table Block Number
1	1	2	3

Table 21 - Programmable Logic Block Default Lookup Table

If the associated Lookup Table does not have an **X-Axis Source** selected, then the output of the Programmable Logic block will always be “Not Available” so long as that table is selected. However, should the Lookup Table be configured for a valid response to an input, be it Data or Time, the output of the Lookup Table function block (i.e. the Y-Axis data that has been selected based on the X-Axis value) will become the output of the Programmable Logic function block so long as that table is selected.

Unlike all other function blocks, the Programmable Logic does NOT perform any linearization calculations between the input and the output data. Instead, it mirrors exactly the input (Lookup Table) data. Therefore, when using the Programmable Logic as a control source for another function block, it is HIGHLY recommended that all the associated Lookup Table Y-Axes either be (a) Set between the 0 to 100% output range or (b) all set to the same scale.

1.11. Math Function Blocks

There are four mathematic function blocks that allow the user to define basic algorithms. Math function block Z = 1 to 4 will be enabled based on sub-index Z in object 4000h **Math Enable**.

A math function block can take up to six input signals, as listed in Table 4 in Section 1.5. Each input is then scaled according the associated scaling and gain objects. A “Math Input X” is determined by the corresponding sub-index X = 1 to 4 of the objects 4y00h **Math Y Input Source** and 4y01h **Math Y Input Number**. Here, y = 1 to 4; corresponding the Math 1- Math 4.

Inputs are converted into a percentage value based on objects 4y20h **Math Y Scaling 1 FV** and 4y22h **Math Y Scaling 2 FV**. Before being used in the calculation, these objects apply the resolution shift defined by object 4y02h **Math Y Decimal Digits FV**. As with any other function block using a control source for the X-Axis in a conversion, the scaling objects should be selected to match the values in the control’s corresponding objects.

For additional flexibility, the user can also adjust object 4y40h **Math Y Input Gain**. This object has a fixed decimal digit resolution of 2, and a range of -100 to 100. By default, each input has a gain of 1.0.

For example, in the case where the user may want to combine two inputs such that a joystick (Input 1) is the primary control of an output, but the speed can be incremented or decremented based on a potentiometer (Input 2), it may be desired that 75% of the scale is controlled by the joystick position, while the potentiometer can increase or decrease the min/max output by up to

25%. In this case, Input 1 would have a gain of 0.75, while Input 2 uses 0.25. The resulting addition will give a command from 0 to 100% based on the combined positions of both inputs.

For each input pair, the appropriate arithmetic or logical operation is performed on the two inputs, InA and InB, according to the associated function in sub-index of InB in object 4y50h **Math Y Operator**. The list of selectable function operations is defined in Table 19.

0	=	True when InA Equals InB
1	!=	True when InA Not Equal InB
2	>	True when InA Greater Than InB
3	>=	True when InA Greater Than or Equal InB
4	<	True when InA Less Than InB
5	<=	True when InA Less Than or Equal InB
6	OR	True when InA or InB is True
7	NOR	True when InA and InB are False
8	AND	True when InA and InB are True
9	NAND	True when InA and InB are not both True
10	XOR	True when InA/InB is True, but not both
11	XNOR	True when InA and InB are both True or False
12	+	Result = InA plus InB
13	-	Result = InA minus InB
14	x	Result = InA times InB
15	/	Result = InA divided by InB
16	MIN	Result = Smallest of InA and InB
17	MAX	Result = Largest of InA and InB

Table 22 - Math Function Operators

For Function 1, InA and InB are Math Inputs 1 and 2, respectively.

For Function 2, InA and InB are Math Inputs 3 and 4, respectively.

For Function 3, InA and InB are Math Inputs 5 and 6, respectively.

Exclusively **within** a Math Block, there is a third control parameter: Object 4y02h, **Math Y Function Number**. This parameter allows for the result of any Function (1, 2 or 3) to be the input to any **Math Input Y** within the same Math Block. Therefore, **Math Y Input Source** must be a Math Block and **Math Y Input Number** must be the same number as being configured. When these four parameters match, if **Math Y Function Number** is set to 1, 2, or 3, the respective input will be the result of the Function selected. By default, **Math Y Function Number** is set to 0 – in which case this parameter is ignored and uses the Math Block output result. These functions can only be used **within** the Math Block. They can not be used for other Math Blocks or logic blocks.

This allows for more versatility within the Math Block. For a valid result in each Function, both inputs must be non-zero value (other than 'Control Source Not Used'). Otherwise, the corresponding Function is ignored. Furthermore, for a valid/expected output result in each Math Block, it is necessary to keep in mind how the Functions link to one another within the Math Block.

For logical operators (6 to 11), any SCALED input greater than or equal to 0.5 is treated as a TRUE input. For logic output operators (0 to 11), the result of the calculation for the function will always be 0 (FALSE) or 1 (TRUE).

Error data (i.e. input measured out of range) is always treated as a 0.0 input into the function.

For the arithmetic functions (12 to 17), it is recommended to scale the data such that the resulting operation will not exceed full scale (0 to 100%) and saturate the output result.

When dividing, a zero InB value will always result is a zero output value for the associated function. When subtracting, a negative result will always be treated as a zero, unless the function is multiplied by a negative one, or the inputs are scaled with a negative coefficient first.

The resulting final mathematical output calculation is in the appropriate physical units using object 4021h **Math Output Scaling 1 PV** and 4023h **Math Output Scaling 2 PV**. These objects are also considered the Min and Max values of the Math Block output and apply the resolution shift defined by object 4032h **Math Output Decimal Digits PV**. The result is written to read-only object 4030h **Math Output PV**. These scaling objects should also be taken into account when the Math Function is selected as the input source for another function block, as outlined in Table 6.

1.12. Simple Conditional Logic Function Blocks

The Simple Conditional Logic Blocks provide a way of connecting different blocks and comparing them to one another. These blocks can be individually enabled with the use of object 4500h **COND LOGIC Enabled**, and the corresponding subindex. The output of the Conditional Logic Blocks is either 0 (FALSE) or 1 (TRUE), and is observable at object 4501h **COND LOGIC Output PV**, again using the appropriate subindex.

Each Conditional Logic Block is made up of one Result Operators and two Conditions. Object 4x10h **COND LOGIC Result Operator** is used to set the Result Operator between the two conditions in each block. Refer to Table 23 for the available operations.

Value	Operation	Meaning
0	OR	True when Op1 or Op2 is True
1	AND	True when Op1 and Op2 are True
2	XOR	True when Op1/Op2 is True, but not both

Table 23 - Available Operations for Conditional Result Operator



When configuring a Conditional Block and only one comparison is needed, it is necessary that operation selected for Conditional Result Operator is set to 1 ('OR, True When Op1 or Op2 is True')

Objects 4x20h **COND LOGIC Condition 1** and 4x25h **COND LOGIC Condition 2** have the same structure and are made up of two arguments and one operator each.

Each argument is made up of one source and one number, these function as described in section 1.5. The operators are used to compare the two arguments and produce a result. The operations for the operators are listed in Table 24.

Value	Operation	Meaning
0	Not Used	Result = False
1	=	True when InA Equals InB
2	!=	True when InA Not Equal InB

3	>	True when InA Greater Than InB
4	>=	True when InA Greater Than or Equal InB
5	<	True when InA Less Than InB
6	<=	True when InA Less Than or Equal InB
7	OR	True when InA or InB is True
8	AND	True when InA and InB are True
9	XOR	True when InA/InB is True, but not both

Table 24 - Available Operation for Conditions 1 and 2 Operators

1.13. Set / Reset Latch Function Blocks

Each Set-Reset Block can be individually enabled or disabled with the use of object 4Fx0h **SRL Enabled**. If enabled, the Set-Reset Block consists of only 2 control sources: object 4Fx1h **SRL Set Control Source** and object 4Fx3h **Reset Source**. The purpose of these blocks is to simulate a modified latching function in which the 'Reset Signal' has more precedence. The 'latching' function works as per the Table 25 below.

'Set Signal'	'Reset Signal'	'Set-Reset Block Output' (Initial State: OFF)
OFF	OFF	Latched State
OFF	ON	OFF
ON	OFF	ON
ON	ON	OFF

Table 25 – Set-Reset Function block operation

The Reset and Set sources have associated with them a minimum and maximum threshold values which determine the ON and OFF state. For the Set source, object 4Fx5 **SRL Set Input On Percent** is the maximum threshold and object 4xF7 **SRL Set Input Off Percent** is the minimum threshold. For the Reset source, object 4Fx6 **SRL Reset Input On Percent** is the maximum threshold and object 4xF8 **SRL Reset Input Off Percent** is the minimum threshold. These objects also allow to have a dead band in between ON/OFF states and they are in terms of percentage of input selected.

As seen in Table 25 above, the 'Reset Signal' has more precedence over the 'Set Signal' - if the state of 'Reset Signal' is ON, the state of 'Set-Reset Block Output' will be OFF. To create an ON state in 'Set-Reset Block Output' the state of 'Reset Signal' must be OFF while the state of 'Set Signal' is ON. In this case, the state of 'Set-Reset Block Output' will remain ON even if 'Set Signal' turns OFF as long as 'Reset Signal' remains OFF. As soon as the 'Reset Signal' turns ON the 'Set-Reset Block Output' will turn OFF regardless of the state of 'Set Signal'.

2. Installation Instructions

2.1. Dimensions and Pinout

The 4-Channel Strain Gauge Input Controller is packaged in a plastic housing from TE Deutsch. The assembly carries an IP67 rating.

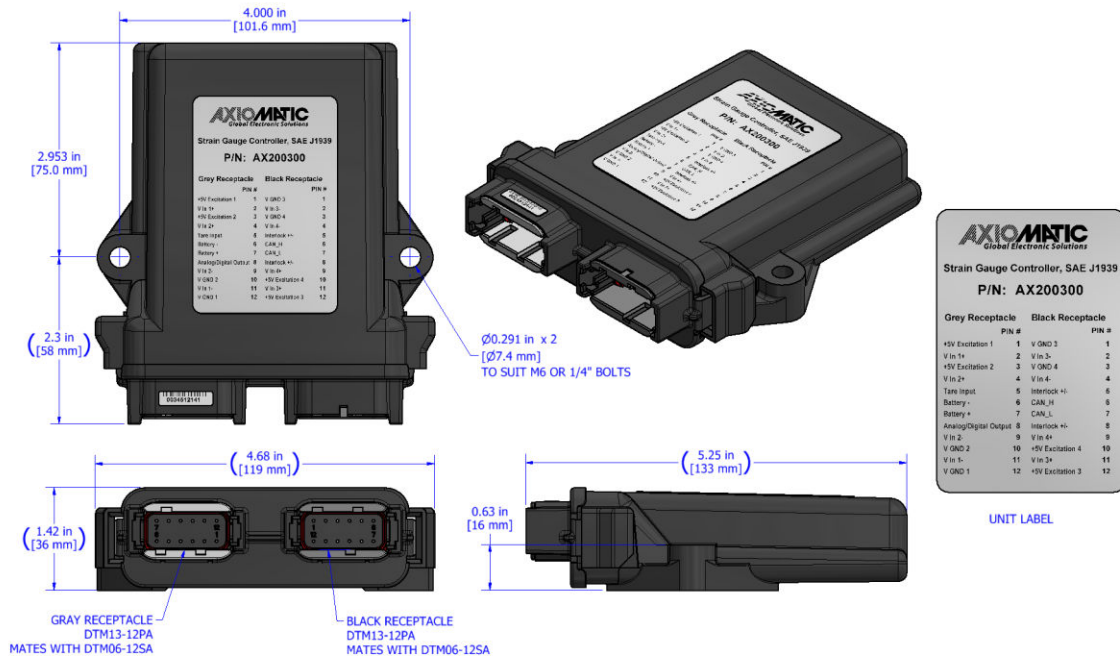

Figure 12 - Housing Dimensions

Grey Connector		Black Connector	
Pin #	Function	Pin #	Function
1	+5V Excitation 1	1	GND 3
2	V IN 1+	2	V IN 3-
3	+5V Excitation 2	3	GND 4
4	V IN 2+	4	V IN 4-
5	Tare Input	5	Interlock +/-
6	BATT-	6	CAN_H
7	BATT+	7	CAN_L
8	Digital Output	8	Interlock +/-
9	V IN 2 -	9	V IN 4+
10	GND 2	10	+5V Excitation 4
11	V IN 1 -	11	V IN 3+
12	GND 1	12	+5V Excitation 3

Table 26 - Connector Pinout

2.2. Mounting Instructions

2.2.1. Notes & Warnings

- Do not install near high-voltage or high-current devices.
- Note the operating temperature range. All field wiring must be suitable for that temperature range.
- Install the unit with appropriate space available for servicing and for adequate wire harness access (15 cm) and strain relief (30 cm).
- Do not connect or disconnect the unit while the circuit is live, unless the area is known to be non-hazardous.

2.2.2. Mounting

Mounting holes sized for ¼ inch or M6 bolts. The bolt length will be determined by the end-user's mounting plate thickness. The mounting flange of the controller is 0.63 inches (16 mm) thick.

All field wiring should be suitable for the operating temperature range.

Install the unit with appropriate space available for servicing and for adequate wire harness access (6 inches or 15 cm) and strain relief (12 inches or 30 cm).

2.2.3. Connections

Use the following TE Deutsch mating plugs to connect to the integral receptacles. Wiring to these mating plugs must be in accordance with all applicable local codes. Suitable field wiring for the rated voltage and current must be used. The rating of the connecting cables must be at least 85°C. For ambient temperatures below –10°C and above +70°C, use field wiring suitable for both minimum and maximum ambient temperature.

Refer to the respective TE Deutsch datasheets for usable insulation diameter ranges and other instructions.

Receptacle Contacts	Mating Sockets as appropriate (Refer to www.laddinc.com for more information on the contacts available for this mating plug.)
Mating Connector	DTM06-12SA, DTM06-12SB, 2 wedges WM12S, 24 contacts (0462-201-20141)

3. CANOPEN® OBJECT DICTIONARY

The CANopen® object dictionary of the 4-CH-SG Controller is based on CiA device profile DS-404 V1.2 (device profile for Closed Loop Controllers). The object dictionary includes Communication Objects beyond the minimum requirements in the profile, as well as several manufacturer-specific objects for extended functionality.

3.1. NODE ID and BAUDRATE

By default, the Controller ships factory programmed with a Node ID = 127 (0x7F) and with Baudrate = 125 kbps.

3.1.1. LSS Protocol to Update

The only means by which the Node-ID and Baudrate can be changed is to use Layer Settling Services (LSS) and protocols as defined by CANopen® standard DS-305.

Follow the steps below to configure either variable using LSS protocol. If required, please refer to the standard for more detailed information about how to use the protocol.

3.1.1.1. Setting Node-ID

- Set the module state to LSS-configuration by **sending** the following message:

<i>Item</i>	<i>Value</i>
COB-ID	0x7E5
Length	2
Data 0	0x04 (cs=4 for switch state global)
Data 1	0x01 (switches to configuration state)

- Set the Node-ID by **sending** the following message:

<i>Item</i>	<i>Value</i>
COB-ID	0x7E5
Length	2
Data 0	0x11 (cs=17 for configure node-id)
Data 1	Node-ID (set new Node-ID as a hexadecimal number)

- The module will send the following response (any other response is a failure).

<i>Item</i>	<i>Value</i>
COB-ID	0x7E4
Length	3
Data 0	0x11 (cs=17 for configure node-id)
Data 1	0x00
Data 2	0x00

- Save the configuration by **sending** the following message:

<i>Item</i>	<i>Value</i>
COB-ID	0x7E5
Length	1
Data 0	0x17 (cs=23 for store configuration)

- The module will send the following response (any other response is a failure):

<i>Item</i>	<i>Value</i>
COB-ID	0x7E4
Length	3
Data 0	0x17 (cs=23 for store configuration)
Data 1	0x00
Data 2	0x00

- Set the module state to LSS-operation by **sending** the following message:
(Note, the module will reset itself back to the pre-operational state)

<i>Item</i>	<i>Value</i>
COB-ID	0x7E5
Length	2
Data 0	0x04 (cs=4 for switch state global)
Data 1	0x00 (switches to waiting state)

3.1.1.2. Setting Baudrate

- Set the module state to LSS-configuration by **sending** the following message:

<i>Item</i>	<i>Value</i>
COB-ID	0x7E5
Length	2
Data 0	0x04 (cs=4 for switch state global)
Data 1	0x01 (switches to configuration state)

- Set the baudrate by **sending** the following message:

<i>Item</i>	<i>Value</i>
COB-ID	0x7E5
Length	3
Data 0	0x13 (cs=19 for configure bit timing parameters)
Data 1	0x00 (switches to waiting state)
Data 2	Index (select baudrate index per Table 21)

<i>Index</i>	<i>Bit Rate</i>
0	1 Mbit/s
1	800 kbit/s
2	500 kbit/s
3	250 kbit/s
4	125 kbit/s (default)
5	reserved (100 kbit/s)

6	50 kbit/s
7	20 kbit/s
8	10 kbit/s

Table 21 – LSS Baudrate Indices

- The module will send the following response (any other response is a failure):

<i>Item</i>	<i>Value</i>
COB-ID	0x7E4
Length	3
Data 0	0x13 (cs=19 for configure bit timing parameters)
Data 1	0x00
Data 2	0x00

- Activate bit timing parameters by **sending** the following message:

<i>Item</i>	<i>Value</i>
COB-ID	0x7E5
Length	3
Data 0	0x15 (cs=19 for activate bit timing parameters)
Data 1	<delay_lsb>
Data 2	<delay_msb>

The delay individually defines the duration of the two periods of time to wait until the bit timing parameters switch is done (first period) and before transmitting any CAN message with the new bit timing parameters after performing the switch (second period). The time unit of switch delay is 1 ms.

- Save the configuration by **sending** the following message (on the NEW baudrate):

<i>Item</i>	<i>Value</i>
COB-ID	0x7E5
Length	1
Data 0	0x17 (cs=23 for store configuration)

- The module will send the following response (any other response is a failure):

<i>Item</i>	<i>Value</i>
COB-ID	0x7E4
Length	3
Data 0	0x17 (cs=23 for store configuration)
Data 1	0x00
Data 2	0x00

- Set the module state to LSS-operation by **sending** the following message:
(Note, the module will reset itself back to the pre-operational state)

<i>Item</i>	<i>Value</i>
COB-ID	0x7E5

Length	2
Data 0	0x04 (cs=4 for switch state global)
Data 1	0x00 (switches to waiting state)

The following screen capture (left) shows the CAN data was sent (7E5h) and received (7E4h) by the tool when the baudrate was changed to 250 kbps using the LSS protocol. The other image (right) shows what was printed on an example debug RS-232 menu while the operation took place.

Between CAN Frame 98 and 99, the baudrate on the CAN Scope tool was changed from 125 to 250 kbps.

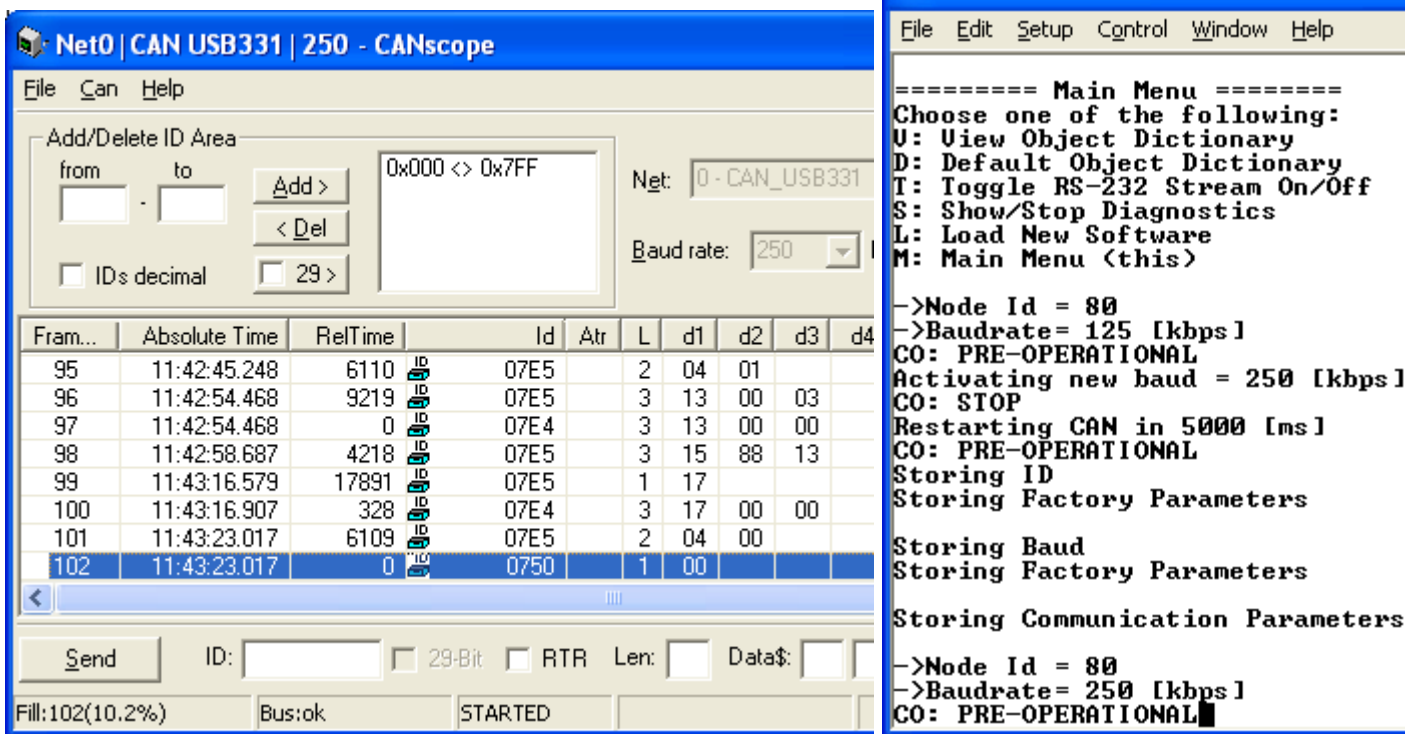

3.2. COMMUNICATION OBJECTS (DS-301 and DS-404)

The communication objects supported by the Controller are listed in the following table. A more detailed description of some of the objects is given in the following subchapters. Only those objects that have device-profile specific information are described. For more information on the other objects, refer to the generic CANopen® protocol specification DS-301.

Index (hex)	Object	Object Type	Data Type	Access	PDO Mapping
1000	Device Type	VAR	UNSIGNED32	RO	No
1001	Error Register	VAR	UNSIGNED8	RO	No
1002	Manufacturer Status Register	VAR	UNSIGNED32	RO	No
1003	Pre-Defined Error Field	ARRAY	UNSIGNED32	RO	No
100C	Guard Time	VAR	UNSIGNED16	RW	No
100D	Life Time Factor	VAR	UNSIGNED8	RW	No
1010	Store Parameters	ARRAY	UNSIGNED32	RW	No

1011	Restore Default Parameters	ARRAY	UNSIGNED32	RW	No
1016	Consumer Heartbeat Time	ARRAY	UNSIGNED32	RW	No
1017	Producer Heartbeat Time	VAR	UNSIGNED16	RW	No
1018	Identity Object	RECORD		RO	No
1020	Verify Configuration	ARRAY	UNSIGNED32	RO	No
1029	Error Behaviour	ARRAY	UNSIGNED8	RW	No
1400	RPDO1 Communication Parameter	RECORD		RW	No
1401	RPDO2 Communication Parameter	RECORD		RW	No
1402	RPDO3 Communication Parameter	RECORD		RW	No
1403	RPDO4 Communication Parameter	RECORD		RW	No
1404	RPDO5 Communication Parameter	RECORD		RW	No
1405	RPDO6 Communication Parameter	RECORD		RW	No
1600	RPDO1 Mapping Parameter	RECORD		RO	No
1601	RPDO2 Mapping Parameter	RECORD		RO	No
1602	RPDO3 Mapping Parameter	RECORD		RO	No
1603	RPDO4 Mapping Parameter	RECORD		RO	No
1604	RPDO5 Mapping Parameter	RECORD		RO	No
1605	RPDO6 Mapping Parameter	RECORD		RO	No
1800	TPDO1 Communication Parameter	RECORD		RW	No
1801	TPDO2 Communication Parameter	RECORD		RW	No
1802	TPDO3 Communication Parameter	RECORD		RW	No
1803	TPDO4 Communication Parameter	RECORD		RW	No
1804	TPDO5 Communication Parameter	RECORD		RW	No
1805	TPDO6 Communication Parameter	RECORD		RW	No
1A00	TPDO1 Mapping Parameter	RECORD		RW	No
1A01	TPDO2 Mapping Parameter	RECORD		RW	No
1A02	TPDO3 Mapping Parameter	RECORD		RW	No
1A03	TPDO4 Mapping Parameter	RECORD		RW	No
1A04	TPDO5 Mapping Parameter	RECORD		RW	No
1A05	TPDO6 Mapping Parameter	RECORD		RW	No

3.2.1. Object 1000h: Device Type

This object contains information about the device type as per device profile DS-404. The 32-bit parameter is divided into two 16-bit values, showing General and Additional information as shown below.

MSB	LSB
Additional Information = 0xE01C	General Information = 0x0194 (404)

DS-404 defines the Additional Information field in the following manner:

- 0000h = reserved
 - 0001h = digital input block
 - 0002h = analog input block
 - 0004h = digital output block
 - 0008h = analog output block
 - 0010h = controller block (aka PID)
 - 0020h = alarm block
 - 0040h ... 0800h = reserved
 - 1000h = reserved
 - 2000h = lookup table block (manufacturer-specific)
 - 4000h = programmable logic block (manufacturer-specific)
- UMAX200301. 4-Channel Strain Gauge Controller. Version: 1.01

8000h = miscellaneous block (manufacturer-specific)

Object Description

Index	1000h
Name	Device Type
Object Type	VAR
Data Type	UNSIGNED32

Entry Description

Access	RO
PDO Mapping	No
Value Range	0xE01F0194
Default Value	0xE01F0194

3.2.2. Object 1001h: Error Register

This object is an error register for the device. Any time there is an error detected by the Controller, the Generic Error Bit (bit 0) is set. This bit will be cleared only if there are no other errors in this module. No other bits in this register are used.

Object Description

Index	1001h
Name	Error Register
Object Type	VAR
Data Type	UNSIGNED8

Entry Description

Access	RO
PDO Mapping	No
Value Range	00h or 01h
Default Value	0

3.2.3. Object 1002h: Manufacturer Status Register

This object is used for manufacturer debug purposes.

3.2.4. Object 1003h: Pre-Defined Error Field

This object provides an error history by listing the errors in the order that they have occurred. An error is added to the top of the list when it occurs, and is immediately removed when the error condition has been cleared. The latest error is always at sub-index 1, with sub-index 0 containing the number of errors currently in the list. When the device is in an error-free state, the value of sub-index 0 is zero.

The error list may be cleared by writing a zero to sub-index 0, which will clear all errors from the list, regardless of whether or not they are still present. Clearing the list does NOT mean that the module will return to the error-free behaviour state if at least one error is still active.

The Controller has a limitation of a maximum of 4 errors in the list. If the device registers more errors, the list will be truncated, and the oldest entries will be lost.

The error codes stored in the list are 32-bit unsigned numbers, consisting of two 16-bit fields. The lower 16-bit field is the EMCY error code, and the higher 16-bit field is a manufacturer-specific code. The manufacturer-specific code is divided into two 8-bit fields, with the higher byte indicating the error description, and the lower byte indicating the channel on which the error occurred.

MSB

LSB

Error Description	Channel-ID	EMCY Error Code
-------------------	------------	-----------------

If node-guarding is used (not recommended per the latest standard) and a lifeguard event occurs, the manufacturer-specific field will be set to 0x1000. On the other hand, if a heartbeat consumer fails to be received within the expected timeframe, the Error Description will be set to 0x80 and the Channel-ID (nn) will reflect the Node-ID of the consumer channel that was not producing. In this case, the manufacturer-specific field will therefore be 0x80nn. In both cases, the corresponding EMCY Error Code will be the Guard Error 0x8130.

When an analog output is not working as described in Section 1.3, then the Error Description will reflect what channel(s) is at fault using the following table. Also, if an RPDO is not received within the expected “Event Timer” period, an RPDO timeout will be flagged. Table 22 outlines the resulting Error Field Codes and their meanings.

Error Field Code	Error Description	Meaning	ID	Meaning	EMCY Code	Meaning
00000000h	EMCY Error Reset (fault no longer active)					
1001F002h	10h	Sensor Break (Open Circuit on AO)	01h	Analog Output 1	F002h	Output Overload
1002F002h	10h	Sensor Break	02h	Analog Output 2	F002h	Output Overload
1003F002h	10h	Sensor Break	03h	Analog Output 3	F002h	Output Overload
1004F002h	10h	Sensor Break	04h	Analog Output 4	F002h	Output Overload
1005F002h	10h	Sensor Break	05h	Analog Output 5	F002h	Output Overload
1006F002h	10h	Sensor Break	06h	Analog Output 6	F002h	Output Overload
1007F002h	10h	Sensor Break	07h	Analog Output 7	F002h	Output Overload
1008F002h	10h	Sensor Break	08h	Analog Output 8	F002h	Output Overload
1009F002h	10h	Sensor Break	09h	Analog Output 9	F002h	Output Overload
100AF002h	10h	Sensor Break	0Ah	Analog Output 10	F002h	Output Overload
20003000h	20h	Positive Overload (Vps Overvoltage)	00h	Unspecified	3000h	Generic Voltage
40003000h	40h	Negative Overload (Vps Undervoltage)	00h	Unspecified	3000h	Generic Voltage
00008100h	00h	RPDO Timeout	00h	Unspecified	8100h	Communication - generic
10008130h	10h	Lifeguard Event	00h	Unspecified	8130h	Lifeguard/Heartbeat Error
80nn8130h	80h	Heartbeat Timeout	nn	Node-ID	8130h	Lifeguard/Heartbeat Error
00008140h	00h	Bus OFF Event	00h	Unspecified	8400h	Bus OFF Recovery

Table 22 – Pre-Defined Error Field Codes

Object Description

Index	1003h
Name	Pre-Defined Error Field
Object Type	ARRAY
Data Type	UNSIGNED32

Entry Description

Sub-Index	0h
Description	Number of entries

Access	RW
PDO Mapping	No
Value Range	0 to 15
Default Value	0

Sub-Index	1h to 15
Description	Standard error field
Access	RO
PDO Mapping	No
Value Range	UNSIGNED32
Default Value	0

3.2.5. Object 100Ch: Guard Time

The objects at index 100Ch and 100Dh shall indicate the configured guard time respective to the lifetime factor. The lifetime factor multiplied with the guard time gives the lifetime for the life guarding protocol described in DS-301. The Guard Time value shall be given in multiples of ms, and a value of 0000h shall disable the life guarding.

It should be noted that this object, and that of 100Dh are only supported for backwards compatibility. The standard recommends that newer networks do not use the life guarding protocol, but rather heartbeat monitoring instead. Both life guarding and heartbeats can NOT be active simultaneously.

Object Description

Index	100Ch
Name	Guard Time
Object Type	VAR
Data Type	UNSIGNED16

Entry Description

Sub-Index	0h
Access	RW
PDO Mapping	No
Value Range	0 to 65535
Default Value	0

3.2.6. Object 100Dh: Lifetime Factor

The lifetime factor multiplied with the guard time gives the lifetime for the life guarding protocol. A value of 00h shall disable life guarding.

Object Description

Index	100Dh
Name	Lifetime factor
Object Type	VAR
Data Type	UNSIGNED8

Entry Description

Sub-Index	0h
Access	RW
PDO Mapping	No
Value Range	0 to 255
Default Value	0

3.2.7. Object 1010h: Store Parameters

This object supports the saving of parameters in non-volatile memory. In order to avoid storage of parameters by mistake, storage is only executed when a specific signature is written to the appropriate sub-index. The signature is “save”.

The signature is a 32-bit unsigned number, composed of the ASCII codes of the signature characters, according to the following table:

MSB		LSB	
e	v	a	s
65h	76h	61h	73h

On reception of the correct signature to an appropriate sub-index, the Controller will store the parameters in non-volatile memory, and then confirm the SDO transmission.

By read access, the object provides information about the module’s saving capabilities. For all sub-indexes, this value is 1h, indicating that the Controller saves parameters on command. **This means that if power is removed before the Store object is written, changes to the Object Dictionary will NOT have been saved in the non-volatile memory, and will be lost on the next power cycle.**

Object Description

Index	1010h
Name	Store Parameters
Object Type	ARRAY
Data Type	UNSIGNED32

Entry Description

Sub-Index	0h
Description	Largest sub-index supported
Access	RO
PDO Mapping	No
Value Range	8
Default Value	8

Sub-Index	1h
Description	Save all parameters
Access	RW
PDO Mapping	No
Value Range	0x65766173 (write access) 1h (read access)
Default Value	1h

Sub-Index	2h
Description	Save communication parameters
Access	RW
PDO Mapping	No
Value Range	0x65766173 (write access) 1h (read access)
Default Value	1h

Sub-Index	3h
Description	Save application parameters
Access	RW
PDO Mapping	No
Value Range	0x65766173 (write access) 1h (read access)
Default Value	1h

Sub-Index	4h
Description	Save manufacturer parameters
Access	RW
PDO Mapping	No
Value Range	0x65766173 (write access) 1h (read access)
Default Value	1h

3.2.8. Object 1011h: Restore Parameters

This object supports the restoring of the default values for the object dictionary in non-volatile memory. In order to avoid restoring of parameters by mistake, the device restores the defaults only when a specific signature is written to the appropriate sub-index. The signature is “load”.

The signature is a 32-bit unsigned number, composed of the ASCII codes of the signature characters, according to the following table:

MSB		LSB	
d	a	o	l
64h	61h	6Fh	6Ch

On reception of the correct signature to an appropriate sub-index, the Controller will restore the defaults in non-volatile memory, and then confirm the SDO transmission. **The default values are set valid only after the device is reset or power-cycled.** This means that the Controller will NOT start using the default values right away, but rather continue to run from whatever values were in the Object Dictionary prior to the restore operation.

By read access, the object provides information about the module’s default parameter restoring capabilities. For all sub-indexes, this value is 1h, indicating that the Controller restores defaults on command.

Object Description

Index	1011h
Name	Restore Default Parameters
Object Type	ARRAY
Data Type	UNSIGNED32

Entry Description

Sub-Index	0h
Description	Largest sub-index supported
Access	RO
PDO Mapping	No
Value Range	4
Default Value	4

Sub-Index	1h
Description	Restore all default parameters
Access	RW
PDO Mapping	No
Value Range	0x64616F6C (write access), 1h (read access)
Default Value	1h

Sub-Index	2h
Description	Restore default communication parameters
Access	RW
PDO Mapping	No
Value Range	0x64616F6C (write access), 1h (read access)
Default Value	1h

Sub-Index	3h
Description	Restore default application parameters
Access	RW
PDO Mapping	No
Value Range	0x64616F6C (write access), 1h (read access)
Default Value	1h

Sub-Index	4h
Description	Restore default manufacturer parameters
Access	RW
PDO Mapping	No
Value Range	0x64616F6C (write access), 1h (read access)
Default Value	1h

3.2.9. Object 1016h: Consumer Heartbeat Time

The Controller can be a consumer of heartbeat objects for a single module. This object defines the expected heartbeat cycle time for that module, and if set to zero, it is not used. When the object is non-zero, the time is a multiple of 1ms, and monitoring will start after the reception of the first heartbeat from the module. If the Controller fails to receive a heartbeat from a node in the expected timeframe, it will indicate a communication error, and respond as per object 1029h.

Bits	31-24	23-16	15-0
Value	Reserved 00h	Node-ID	Heartbeat time
Encoded as		UNSIGNED8	UNSIGNED16

Object Description

Index	1016h
Name	Consumer heartbeat time
Object Type	ARRAY
Data Type	UNSIGNED32

Entry Description

Sub-Index	0h
Description	Number of entries
Access	RO
PDO Mapping	No
Value Range	1
Default Value	1

Sub-Index	1h
Description	Consumer heartbeat time
Access	RW
PDO Mapping	No
Value Range	UNSIGNED32
Default Value	0

3.2.10. Object 1017h: Producer Heartbeat Time

The Controller could be configured to produce a cyclical heartbeat by writing a non-zero value to this object. The value will be given in multiples of 1ms, and a value of 0 shall disable the heartbeat.

Object Description

Index	1017h
Name	Producer heartbeat time
Object Type	VAR
Data Type	UNSIGNED16

Entry Description

Sub-Index	0h
Access	RW
PDO Mapping	No
Value Range	10 to 65535
Default Value	0

3.2.11. Object 1018h: Identity Object

The identity object indicates the data of the Controller, including vendor id, device id, software and hardware version numbers, and the serial number.

In the Revision Number entry at sub-index 3, the format of the data is as shown below

MSB

LSB

Major revision number (object dictionary)	Hardware Revision	Software Version
---	-------------------	------------------

Object Description

Index	1018h
Name	Identity Object
Object Type	RECORD
Data Type	Identity Record

Entry Description

Sub-Index	0h
Description	Number of entries
Access	RO
PDO Mapping	No
Value Range	4
Default Value	4

Sub-Index	1h
Description	Vendor ID
Access	RO
PDO Mapping	No
Value Range	0x00000055
Default Value	0x00000055 (Axiomatic)

Sub-Index	2h
Description	Product Code
Access	RO
PDO Mapping	No
Value Range	0xAA021211
Default Value	0xAA021211

Sub-Index	3h
Description	Revision Number
Access	RO
PDO Mapping	No
Value Range	UNSIGNED32
Default Value	0x00010201

Sub-Index	4h
Description	Serial Number
Access	RO
PDO Mapping	No
Value Range	UNSIGNED32
Default Value	No

3.2.12. Object 1020h: Verify Configuration

This object can be read to see what date the software (version identified in object 1018h) was compiled. The date is represented as a hexadecimal value showing day/month/year as per the format below. The time value at sub-index 2 is a hexadecimal value showing the time in a 24-hour clock

MSB		LSB
Day (in 1-Byte Hex)	Month (in 1-Byte Hex)	Year (in 2-Byte Hex)
00	00	Time (in 2-Byte Hex)

For example, a value of 0x30042014 would indicate that the software was compiled on April 30th, 2014. A time value of 0x00001842 would indicate it was compiled at 6:42pm.

Object Description

Index	1020h
Name	Verify configuration
Object Type	ARRAY
Data Type	UNSIGNED32

Entry Description

Sub-Index	0h
Description	Number of entries
Access	RO
PDO Mapping	No
Value Range	2
Default Value	2

Sub-Index	1h
Description	Configuration date
Access	RO
PDO Mapping	No
Value Range	UNSIGNED32
Default Value	No

Sub-Index	2h
Description	Configuration time
Access	RO
PDO Mapping	No
Value Range	UNSIGNED32
Default Value	No

3.2.13. Object 1029h: Error Behaviour

This object controls the state that the Controller will be set into in case of an error of the type associated with the sub-index.

A network fault is flagged when an RPDO is not received within the expected time period defined in the “Event Timer” of the associated communication objects, (see Section 2.2.14 for more information) or if a lifeguard or heartbeat message is not received as expected. Input faults are defined in Section 1.3, and output faults are defined in Section 1.3. Power Supply faults are described in Section 1.8.

For all sub-indexes, the following definitions hold true:

- 0 = Pre-Operational (node reverts to a pre-operational state when this fault is detected)
- 1 = No State Change (node remains in the same state it was in when the fault occurred)
- 2 = Stopped (node goes into stopped mode when the fault occurs)

Object Description

Index	1029h
Name	Error Behaviour
Object Type	ARRAY
Data Type	UNSIGNED8

Entry Description

Sub-Index	0h
Description	Number of entries
Access	RO
PDO Mapping	No
Value Range	5
Default Value	5

Sub-Index	1h
Description	Communication Fault
Access	RW
PDO Mapping	No
Value Range	See above
Default Value	1 (No State Change)

Sub-Index	2h
Description	Digital Input Fault (not used)
Access	RW
PDO Mapping	No
Value Range	See above
Default Value	1 (No State Change)

Sub-Index	3h
Description	Analog Input Fault (not used)
Access	RW
PDO Mapping	No
Value Range	See above
Default Value	1 (No State Change)

Sub-Index	4h
Description	Digital Output Fault (1 to 10)
Access	RW
PDO Mapping	No
Value Range	See above
Default Value	1 (No State Change)

Sub-Index	5h
Description	Analog Output Fault (1 to 10)

Access	RW
PDO Mapping	No
Value Range	See above
Default Value	1 (No State Change)

3.2.14. RPDO Behaviour

Per the CANopen® standard DS-301, the following procedure shall be used for re-mapping, and is the same for both RPDOs and TPDOs:

- Destroy the PDO by setting bit **exists** (most significant bit) of sub-index 01h of the according PDO communication parameter to 1b
- Disable mapping by setting sub-index 00h of the corresponding mapping object to 0
- Modify the mapping by changing the values of the corresponding sub-indices
- Enable mapping by setting sub-index 00h to the number of mapped objects
- Create the PDO by setting bit **exists** (most significant bit) of sub-index 01h of the according PDO communication parameter to 0b

The Controller can support up to six RPDO messages. All RPDOs on the Controller use the similar default communication parameters, with the PDO IDs set according to the pre-defined connection set described in DS-301. Most RPDOs do not exist, there is no RTR allowed, they use 11-bit CAN-IDs (base frame valid) and they are all event-driven. While all six have valid default mappings defined (see below) only RPDO1 is enabled by default (i.e. RPDO exists).

RPDO1 Mapping at Object 1600h: Default ID 0x200 + Node ID

Sub-Index	Value	Object
0	4	Number of mapped application objects in PDO
1	0x73000110	Analog Output 1 Process Value
2	0x73000210	Analog Output 2 Process Value
3	0x73000310	Analog Output 3 Process Value
4	0x73000410	Analog Output 4 Process Value

RTPDO2 Mapping at Object 1601h: Default ID 0x300 + Node ID

Sub-Index	Value	Object
0	4	Number of mapped application objects in PDO
1	0x73000510	Analog Output 5 Process Value
2	0x73000610	Analog Output 6 Process Value
3	0x73000710	Analog Output 7 Process Value
4	0x73000810	Analog Output 8 Process Value

RPDO3 Mapping at Object 1602h: Default ID 0x400 + Node ID

Sub-Index	Value	Object
0	4	Number of mapped application objects in PDO
1	0x73000910	Analog Output 9 Process Value
2	0x73000A10	Analog Output 10 Process Value
3	0x25000110	Extra Received 1 PV (i.e. Lookup Table 1 X-Axis)
4	0x25000210	Extra Received 2 PV (i.e. Lookup Table 2 X-Axis)

RPDO4 Mapping at Object 1603h: Default ID 0x500 + Node ID

Sub-Index	Value	Object
------------------	--------------	---------------

0	4	Number of mapped application objects in PDO
1	0x25000310	Extra Received 5 PV (i.e. Lookup Table 2 X-Axis)
2	0x25000410	Extra Received 6 PV (i.e. Lookup Table 3 X-Axis)
3	0x25000510	Extra Received 7 PV (i.e. Lookup Table 4 X-Axis)
4	0x25000610	Extra Received 8 PV (i.e. Lookup Table 5 X-Axis)

RPDO5 Mapping at Object 1604h: Default ID 0x200 + Node ID + 1

Sub-Index	Value	Object
0	4	Number of mapped application objects in PDO
1	0x25000710	Extra Received 9 PV (i.e. Lookup Table 6 X-Axis)
2	0x25000810	Extra Received 10 PV (i.e. Lookup Table 7 X-Axis)
3	0x25000910	Extra Received 11 PV (i.e. Lookup Table 8 X-Axis)
4	0x25000A10	Extra Received 12 PV (i.e. Lookup Table 9 X-Axis)

RPDO6 Mapping at Object 1605h: Default ID 0x300 + Node ID + 1

Sub-Index	Value	Object
0	0	Number of mapped application objects in PDO
1	0x25000B10	Extra Received 13 PV (i.e. Math Block 1 X-Axis Source)
2	0x25000C10	Extra Received 14 PV (i.e. Math Block 2 X-Axis Source)
3	0x25000D10	Extra Received 15 PV (i.e. Math Block 3 X-Axis Source)
4	0x25000E10	Extra Received 16 PV (i.e. Math Block 4 X-Axis Source)

None of them have the timeout feature enabled, i.e. the “Event Timer” on sub-index 5 is set to zero. When this is changed to a non-zero value, if the RPDO has not been received from another node within the time period defined (while in Operational mode), a network fault is activated, and the controller will go to the operational state define in Object 1029h sub-index 4.

Object Description

Index	1400h to 1405h
Name	RPDO communication parameter
Object Type	RECORD
Data Type	PDO Communication Record

Entry Description

Sub-Index	0h
Description	Number of entries
Access	RO
PDO Mapping	No
Value Range	5
Default Value	5

Sub-Index	1h
Description	COB-ID used by RPDO
Access	RW
PDO Mapping	No
Value Range	See value definition in DS-301
Default Value	40000000h + RPDO1 + Node ID C0000000h + RPDOx + Node-ID

X	RPDOx ID
1	0200h
2	0300h
3	0400h
4	0500h
5	0201h
6	0301h

Node-ID = Node-ID of the module. The RPDO COB-IDs are automatically updated if the Node-ID is changed by LSS protocol.

80000000h in the COB-ID indicates that the PDO does not exist (destroyed)
 04000000h in the COB-ID indicates that there is no RTR allowed on the PDO

Sub-Index	2h
Description	Transmission type
Access	RO
PDO Mapping	No
Value Range	See value definition in DS-301
Default Value	255 (FFh) = Event Driven

Sub-Index	3h
Description	Inhibit Time
Access	RW
PDO Mapping	No
Value Range	See value definition in DS-301
Default Value	0

Sub-Index	4h
Description	Compatibility entry
Access	RW
PDO Mapping	No
Value Range	UNSIGNED8
Default Value	0

Sub-Index	5
Description	Event-timer
Access	RW
PDO Mapping	No
Value Range	See value definition in DS-301
Default Value	0

Recall: A non-zero event timer for an RPDO means that it will result in a network fault being flagged if it has not been received within this timeframe while in Operational mode.

3.2.15. TPDO Behaviour

The Controller can support up to eight TPDO messages. All TPDOs on the Controller use the similar default communication parameters, with the PDO IDs set according to the pre-defined connection set described in DS-301. Most TPDOs do not exist, there is no RTR allowed, they use 11-bit CAN-IDs (base frame valid) and they are all time-driven. While all have valid default mappings defined (see below) only TPDO1 to TPDO3 are enabled by default (i.e. TPDO exists).

TPDO1 Mapping at Object 1A00h: Default ID 0x180 + Node ID

Sub-Index	Value	Object
0	4	Number of mapped application objects in PDO
1	0x73300110	Analog Output 1 Field Value
2	0x73300210	Analog Output 2 Field Value
3	0x73300310	Analog Output 3 Field Value
4	0x73300410	Analog Output 4 Field Value

TPDO2 Mapping at Object 1A01h: Default ID 0x280 + Node ID

Sub-Index	Value	Object
------------------	--------------	---------------

0	4	Number of mapped application objects in PDO
1	0x73300510	Analog Output 5 Field Value
2	0x73300610	Analog Output 6 Field Value
3	0x73300710	Analog Output 7 Field Value
4	0x73300810	Analog Output 8 Field Value

TPDO3 Mapping at Object 1A02h: Default ID 0x380 + Node ID

Sub-Index	Value	Object
0	4	Number of mapped application objects in PDO
1	0x73300910	Analog Output 9 Field Value
2	0x73300A10	Analog Output 10 Field Value
3	0x23700110	Analog Output 1 Feedback Field Value
4	0x23700210	Analog Output 2 Feedback Field Value

TPDO4 Mapping at Object 1A03h: Default ID 0x480 + Node ID

Sub-Index	Value	Object
0	4	Number of mapped application objects in PDO
1	0x23700310	Analog Output 3 Feedback Field Value
2	0x23700410	Analog Output 4 Feedback Field Value
3	0x23700510	Analog Output 5 Feedback Field Value
4	0x23700610	Analog Output 6 Feedback Field Value

TPDO5 Mapping at Object 1A04h: Default ID 0x180 + Node ID + 1

Sub-Index	Value	Object
0	4	Number of mapped application objects in PDO
1	0x23700710	Analog Output 7 Feedback Field Value
2	0x23700810	Analog Output 8 Feedback Field Value
3	0x23700910	Analog Output 9 Feedback Field Value
4	0x23700A10	Analog Output 10 Feedback Field Value

TPDO6 Mapping at Object 1A05h: Default ID 0x280 + Node ID + 1

Sub-Index	Value	Object
0	2	Number of mapped application objects in PDO
1	0x50200020	Power Supply Field Value (measured)
2	0x50300020	Processor Temperature Field Value (measured)
3	0	Not used by default
4	0	Not used by default

Since only TPDO1 to TPDO3 have a non-zero value transmission rate (i.e. Event Timer in sub-index 5 of communication object), only these TPDOs will be automatically broadcasted when the unit goes into OPERATIONAL mode.

Object Description

Index	1800h to 1805h
Name	TPDO communication parameter
Object Type	RECORD
Data Type	PDO Communication Record

Entry Description

Sub-Index	0h
Description	Number of entries
Access	RO
PDO Mapping	No
Value Range	5
Default Value	5

Sub-Index	1h
Description	COB-ID used by TPDO
Access	RW
PDO Mapping	No
Value Range	See value definition in DS-301
Default Value	40000000h + TPDOx + Node-ID C0000000h + TPDOy + Node-ID

X	TPDOx ID	Y	TPDOy ID
1	0180h	4	0480h
2	0280h	5	0181h
3	0380h	6	0281h
		7	0381h
		8	0481h

Node-ID = Node-ID of the module. The TPDO COB-IDs are automatically updated if the Node-ID is changed by LSS protocol.

80000000h in the COB-ID indicates that the PDO does not exist (destroyed)

04000000h in the COB-ID indicates that there is no RTR allowed on the PDO

Sub-Index	2h
Description	Transmission type
Access	RO
PDO Mapping	No
Value Range	See value definition in DS-301
Default Value	254 (FEh) = Event Driven

Sub-Index	3h
Description	Inhibit Time
Access	RW
PDO Mapping	No
Value Range	See value definition in DS-301
Default Value	0

Sub-Index	4h
Description	Compatibility entry
Access	RW
PDO Mapping	No
Value Range	UNSIGNED8
Default Value	0

Sub-Index	5
Description	Event-timer
Access	RW
PDO Mapping	No
Value Range	See value definition in DS-301
Default Value	100ms (on TPDO1,TPDO2, TPDO3) 0ms (on TPDO4 to TPDO8)

3.3. APPLICATION OBJECTS (DS-404)

Index (hex)	Object	Object Type	Data Type	Access	PDO Mapping
6020	DI Read State	ARRAY	UNSIGNED8	RW	Yes
6030	DI Polarity	ARRAY	UNSIGNED8	RW	No
6220	DO Write State	ARRAY	UNSIGNED8	RW	Yes
6302	AO Decimal Digits PV	ARRAY	UNSIGNED8	RW	No
6332	AO Decimal Digits FV	ARRAY	UNSIGNED8	RW	No
7300	AO Output Process Value	ARRAY	INTEGER16	RW	Yes
7320	AO Output Scaling 1 PV	ARRAY	INTEGER16	RW	No
7321	AO Output Scaling 1 FV	ARRAY	INTEGER16	RW	No
7322	AO Output Scaling 2 PV	ARRAY	INTEGER16	RW	No
7323	AO Output Scaling 2 FV	ARRAY	INTEGER16	RW	No
7330	AO Output Field Value	ARRAY	INTEGER16	RO	Yes

3.3.1. Object 6020h: DI Read State

This object can be used to track the state of the Digital Input reading.

Object Description

Index	6020h
Name	DI Read State
Object Type	ARRAY
Data Type	UNSIGNED8

Entry Description

Sub-Index	0h
Description	Largest sub-index supported
Access	RO
PDO Mapping	Yes
Value Range	1
Default Value	1

Sub-Index	1h
Description	DI Read State
Access	RW
PDO Mapping	Yes
Value Range	0 to 1
Default Value	0

3.3.2. Object 6030h: DI Polarity

This object is used to define the polarity of the Digital Input. See Section 1.4.1 for more information.

Object Description

Index	6030h
Name	DI Polarity
Object Type	ARRAY
Data Type	UNSIGNED8

Entry Description

Sub-Index	0h
Description	Largest sub-index supported
Access	RO
PDO Mapping	Yes
Value Range	1
Default Value	1

Sub-Index	1h
Description	DI Polarity
Access	RW
PDO Mapping	Yes
Value Range	0 to 2
Default Value	0

3.3.3. Object 6220h: DO Write State

This object is used to track the state of the Digital Output. The Analog/Digital Output must be configured as a Digital Output to enable this object's usage. See Section 1.6 for more information.

Object Description

Index	6220h
Name	DO Write State
Object Type	ARRAY
Data Type	UNSIGNED8

Entry Description

Sub-Index	0h
Description	Largest sub-index supported
Access	RO
PDO Mapping	Yes
Value Range	1
Default Value	1

Sub-Index	1h
Description	DO Write State
Access	RW
PDO Mapping	Yes
Value Range	0 to 1
Default Value	0

3.3.4. Object 6302h: AO Decimal Digits PV

This object describes the number of digits following the decimal point (i.e. resolution) of the output control data, which is interpreted with data type INTEGER16 in the process value object.

Object Description

Index	6302h
Name	AO Decimal Digits PV
Object Type	ARRAY
Data Type	UNSIGNED8

Entry Description

Sub-Index	0h
Description	Largest sub-index supported
Access	RO
PDO Mapping	No
Value Range	1
Default Value	1

Sub-Index	1h
Description	AO Decimal Digits PV
Access	RW
PDO Mapping	No
Value Range	0 to 4
Default Value	0

3.3.5. Object 6332h: AO Decimal Digits FV

This object describes the number of digits following the decimal point (i.e. resolution) of the output control data, which is interpreted with data type INTEGER16 in the process value object.

Object Description

Index	6332h
Name	AO Decimal Digits FV
Object Type	ARRAY
Data Type	UNSIGNED8

Entry Description

Sub-Index	0h
Description	Largest sub-index supported
Access	RO
PDO Mapping	No
Value Range	1
Default Value	1

Sub-Index	1h
Description	AO Decimal Digits FV
Access	RW
PDO Mapping	No
Value Range	0 to 4
Default Value	0

3.3.6. Object 7300h: AO Output Process Value

This object represents the process value of the output. The Analog/Digital Output must be configured as an Analog Output to enable this object's usage. See Section 1.6 for more information.

Object Description

Index	7300h
Name	Analog Output Process Value
Object Type	ARRAY
Data Type	INTEGER16

Entry Description

Sub-Index	0h
Description	Largest sub-index supported
Access	RO
PDO Mapping	No
Value Range	1
Default Value	1

Sub-Index	1h
Description	AO Process Value
Access	RW
PDO Mapping	Yes
Value Range	INTEGER16
Default Value	No

3.3.7. Object 7320h: AO Output Scaling 1 PV

This object defines the minimum value of the input, and should be specified to equal the corresponding scaling object of the control source. It will be scaled in the physical unit of the control source. The resolution will ALWAYS be dependent on object 6302h AO Decimal Digits PV, even when the output is not being controlled directly by the AO Output PV object 7300h. This object must always be smaller than object 7322h AO Output Scaling 2 PV.

Object Description

Index	7320h
Name	AO Output Scaling 1 PV
Object Type	ARRAY
Data Type	INTEGER16

Entry Description

Sub-Index	0h
Description	Largest sub-index supported
Access	RO
PDO Mapping	No
Value Range	1
Default Value	1

Sub-Index	1h
Description	AO Scaling 1 PV

Access	RW
PDO Mapping	No
Value Range	See Table 6
Default Value	500 [mA]

3.3.8. Object 7321h: AO Output Scaling 1 FV

This object defines the output field value when the input data is at or below the AO Output Scaling 1 PV value. It will be scaled in the physical unit of the output, dependent on type, with the resolution defined in object 6332h AO Decimal Digits FV. The value can be set anywhere within the allowable output range as outlined in Table 3. This value can be set higher than object 7323h AO Output Scaling 2 FV for an inverse response (i.e. decreasing) to an increasing input.

Object Description

Index	7321h
Name	AO Output Scaling 1 FV
Object Type	ARRAY
Data Type	INTEGER16

Entry Description

Sub-Index	0h
Description	Largest sub-index supported
Access	RO
PDO Mapping	No
Value Range	10
Default Value	10

Sub-Index	1h
Description	AO Scaling 1 FV
Access	RW
PDO Mapping	No
Value Range	Dependent on type (see Table 3)
Default Value	0 [mA]

3.3.9. Object 7322h: AO Output Scaling 2 PV

This object defines the maximum value of the input, and should be specified to equal the corresponding scaling object of the control source. It will be scaled in the physical unit of the control source. The resolution will ALWAYS be dependent on object 6302h AO Decimal Digits PV, even when the output is not being controlled directly by the AO Output PV object 7300h. This object must always be larger than object 7322h AO Output Scaling 2 PV.

Object Description

Index	7322h
Name	AO Output Scaling 2 PV
Object Type	ARRAY
Data Type	INTEGER16

Entry Description

Sub-Index	0h
Description	Largest sub-index supported

Access	RO
PDO Mapping	No
Value Range	10
Default Value	10

Sub-Index	1h
Description	AO Scaling 2 PV
Access	RW
PDO Mapping	No
Value Range	See Table 6
Default Value	4500 [mV]

3.3.10. Object 7323h: AO Output Scaling 2 FV

This object defines the output field value when the input data is at or above the AO Output Scaling 2 PV value. It will be scaled in the physical unit of the output, dependent on type, with the resolution defined in object 6332h AO Decimal Digits FV. The value can be set anywhere within the allowable output range as outlined in Table 3. This value can be set lower than object 7321h AO Output Scaling 1 FV for an inverse response (i.e. decreasing) to an increasing input.

Object Description

Index	7323h
Name	AO Output Scaling 2 FV
Object Type	ARRAY
Data Type	INTEGER16

Entry Description

Sub-Index	0h
Description	Largest sub-index supported
Access	RO
PDO Mapping	No
Value Range	10
Default Value	10

Sub-Index	1h
Description	AO Scaling 2 FV
Access	RW
PDO Mapping	No
Value Range	Dependent on type (see Table 3)
Default Value	1500 [mA]

3.3.11. Object 7330h: AO Output Field Value

This object represents the target output drive field value as a result of the output logic and the scaling applied. It is defined in the physical unit of the output dependent on type. The resolution of the object is defined in object 6332h AO Decimal Digits FV.

Object Description

Index	7330h
Name	Analog Output Field Value

Object Type	ARRAY
Data Type	INTEGER16

Entry Description

Sub-Index	0h
Description	Largest sub-index supported
Access	RO
PDO Mapping	No
Value Range	10
Default Value	10

Sub-Index	1h
Description	AO Field Value
Access	RO
PDO Mapping	Yes
Value Range	INTEGER16
Default Value	No

3.4. MANUFACTURER OBJECTS

<i>Index (hex)</i>	<i>Object</i>	<i>Object Type</i>	<i>Data Type</i>	<i>Access</i>	<i>PDO Mapping</i>
2020	DI Pull Up/Down Mode	ARRAY	UNSIGNED8	RW	No
2040	DI Digital Output Feedback	ARRAY	UNSIGNED8	RW	No
2050	DI Long Press Time	ARRAY	UNSIGNED16	RW	No
2060	DI One Press Operation	ARRAY	UNSIGNED8	RW	No
2070	DI Two Press Operation	ARRAY	UNSIGNED8	RW	No
2080	DI Three Press Operation	ARRAY	UNSIGNED8	RW	No
2090	DI Four Press Operation	ARRAY	UNSIGNED8	RW	No
20A0	DI Time Between Presses	ARRAY	UNSIGNED16	RW	No
2100	SGADC Enabled	VAR	UNSIGNED8	RW	No
2101	SGADC Digital Filter	VAR	UNSIGNED8	RW	No
2102	SGADC Data Rate	VAR	UNSIGNED8	RW	No
2103	SGADC Gain Select	VAR	UNSIGNED8	RW	No
2104	SGADC Burnout Time	VAR	UNSIGNED16	RW	No
2105	SGADC Error Detect Enable	VAR	UNSIGNED8	RW	No
2106	SGADC Error React Delay	VAR	UNSIGNED16	RW	No
2110	SGIN Weight Units	ARRAY	UNSIGNED8	RW	No
2111	SGIN Auto Null	ARRAY	UNSIGNED8	RW	No
2112	SGIN Auto Null Offset	ARRAY	INTEGER32	RW	No
2113	SGIN Rated Weight	ARRAY	INTEGER32	RW	No
2114	SGIN Sensitivity	ARRAY	INTEGER32	RW	No
2115	SGIN Minimum Range	ARRAY	INTEGER32	RW	No
2116	SGIN Maximum Range	ARRAY	INTEGER32	RW	No
2117	SGIN Minimum Error	ARRAY	INTEGER32	RW	No
2118	SGIN Maximum Error	ARRAY	INTEGER32	RW	No
2119	SGIN Error Detect Enable	ARRAY	UNSIGNED8	RW	No
211A	SGIN Error Clear Hysteresis	ARRAY	INTEGER16	RW	No
211B	SGIN Error React Delay	ARRAY	UNSIGNED16	RW	No
211C	SGIN Input FV	ARRAY	INTEGER32	RO	Yes

211D	SGIN mV Input PV	ARRAY	INTEGER32	RO	Yes
211E	SGIN Weight Input PV	ARRAY	INTEGER32	RO	Yes
211F	SGIN Decimal Digits PV	ARRAY	UNSIGNED8	RW	No
2200	AO DO Output Type	ARRAY	UNSIGNED8	RW	No
2210	AO DO Control Source	ARRAY	UNSIGNED8	RW	No
2211	AO DO Control Number	ARRAY	UNSIGNED8	RW	No
2230	DO Logic Type	ARRAY	UNSIGNED8	RW	No
2231	DO Toggle Frequency	ARRAY	UNSIGNED16	RW	No
2235	DO Off State Delay	ARRAY	UNSIGNED16	RW	No
2236	DO On State Delay	ARRAY	UNSIGNED16	RW	No
2250	DO Enable Source	ARRAY	UNSIGNED8	RW	No
2251	DO Enable Number	ARRAY	UNSIGNED8	RW	No
2252	DO Enable Response	ARRAY	UNSIGNED8	RW	No
2253	DO Enable Delay	ARRAY	UNSIGNED8	RW	No
2260	DO Override Source	ARRAY	UNSIGNED8	RW	No
2261	DO Override Number	ARRAY	UNSIGNED8	RW	No
2262	DO Override Response	ARRAY	UNSIGNED8	RW	No
2263	DO Override State	ARRAY	UNSIGNED8	RW	No
2260	DO Unlatch Source	ARRAY	UNSIGNED8	RW	No
2261	DO Unlatch Number	ARRAY	UNSIGNED8	RW	No
2310	AO Error Detect Enable	ARRAY	UNSIGNED8	RW	No
2311	AO Error Clear Hysteresis	ARRAY	INTEGER16	RW	No
2312	AO Error React Delay	ARRAY	UNSIGNED16	RW	No
2320	AO Output Range	ARRAY	UNSIGNED8	RW	No
2321	AO Slew Rate Control	ARRAY	UNSIGNED8	RW	No
2322	AO Slew Rate Step Options	ARRAY	UNSIGNED8	RW	No
2323	AO Slew Rate Clock Options	ARRAY	UNSIGNED8	RW	No
2380	AO Output Frequency	ARRAY	INTEGER16	RW	No
2400	RLY Output Type	ARRAY	UNSIGNED8	RW	No
2401	RLY Logic Type	ARRAY	UNSIGNED8	RW	No
2402	RLY Toggle Frequency	ARRAY	UNSIGNED16	RW	No
2405	RLY Off State Delay	ARRAY	UNSIGNED16	RW	No
2406	RLY On State Delay	ARRAY	UNSIGNED16	RW	No
2407	RLY Write State	ARRAY	UNSIGNED8	RW	Yes
2410	RLY Control Source	ARRAY	UNSIGNED8	RW	No
2411	RLY Control Number	ARRAY	UNSIGNED8	RW	No
2420	RLY Enable Source	ARRAY	UNSIGNED8	RW	No
2421	RLY Enable Number	ARRAY	UNSIGNED8	RW	No
2422	RLY Enable Response	ARRAY	UNSIGNED8	RW	No
2423	RLY Enable Delay	ARRAY	UNSIGNED16	RW	No
2430	RLY Override Source	ARRAY	UNSIGNED8	RW	No
2431	RLY Override Number	ARRAY	UNSIGNED8	RW	No
2432	RLY Override Response	ARRAY	UNSIGNED8	RW	No
2433	RLY Override State	ARRAY	UNSIGNED8	RW	No
2440	RLY Unlatch Source	ARRAY	UNSIGNED8	RW	No
2441	RLY Unlatch Number	ARRAY	UNSIGNED8	RW	No
2500	EC Extra Received Process Value	ARRAY	INTEGER16	RW	Yes
2502	EC Decimal Digits PV	ARRAY	UNSIGNED8	RW	No
2520	EC Scaling 1 PV	ARRAY	INTEGER16	RW	No
2522	EC Scaling 2 PV	ARRAY	INTEGER16	RW	No
2600	CAN Tare	RECORD	UNSIGNED8	RW	Yes
5010	Constant Field Value	ARRAY	FLOAT32	RW	No
5020	Power Supply Field Value	VAR	FLOAT32	RO	Yes

5020	Processor Temperature Field Value	VAR	FLOAT32	RO	Yes
5555	Start in Operational Mode	VAR	BOOLEAN	RW	No

3.4.1. Object 2020h: DI Pull Up/Down Mode

This object is used to define if a Pull-Up or Pull-Down network is applied to the Digital Input.

Object Description

Index	2020h
Name	DI Pull Up/Down Mode
Object Type	ARRAY
Data Type	UNSIGNED8

Entry Description

Sub-Index	0h
Description	Largest sub-index supported
Access	RO
PDO Mapping	No
Value Range	1
Default Value	1

Sub-Index	1h
Description	DI Pull Up/Down Mode
Access	RW
PDO Mapping	No
Value Range	0 to 2
Default Value	0

3.4.2. Object 2040h: DI Digital Output Feedback

This object is used to define how feedback for the Digital Input is handled, either through the Digital Output or Interlock Output if used.

Object Description

Index	2040h
Name	DI Digital Output Feedback
Object Type	ARRAY
Data Type	UNSIGNED8

Entry Description

Sub-Index	0h
Description	Largest sub-index supported
Access	RO
PDO Mapping	No
Value Range	1
Default Value	1

Sub-Index	1h
-----------	----

Description	DI Digital Output Feedback
Access	RW
PDO Mapping	No
Value Range	0 to 2
Default Value	0

3.4.3. Object 2050h: DI Long Press Time

This object is used to define the amount of time it takes to enter calibration mode via the Tare Input.

Object Description

Index	2050h
Name	DI Long Press Time
Object Type	ARRAY
Data Type	UNSIGNED8

Entry Description

Sub-Index	0h
Description	Largest sub-index supported
Access	RO
PDO Mapping	No
Value Range	1
Default Value	1

Sub-Index	1h
Description	DI Long Press Time
Access	RW
PDO Mapping	No
Value Range	0 to 10000
Default Value	1000 [ms]

3.4.4. Object 2060h: DI One Press Operation

This object is used to define the operation executed by the Tare Input in calibration mode when pressed one time. The operations can be seen on Table 5.

Object Description

Index	2060h
Name	DI One Press Operation
Object Type	ARRAY
Data Type	UNSIGNED8

Entry Description

Sub-Index	0h
Description	Largest sub-index supported
Access	RO
PDO Mapping	No
Value Range	1

Default Value	1
---------------	---

Sub-Index	1h
Description	DI One Press Operation
Access	RW
PDO Mapping	No
Value Range	0 to 7
Default Value	0

3.4.5. Object 2070h: DI Two Press Operation

This object is used to define the operation executed by the Tare Input in calibration mode when pressed two times. The operations can be seen on Table 5.

Object Description

Index	2070h
Name	DI Two Press Operation
Object Type	ARRAY
Data Type	UNSIGNED8

Entry Description

Sub-Index	0h
Description	Largest sub-index supported
Access	RO
PDO Mapping	No
Value Range	1
Default Value	1

Sub-Index	1h
Description	DI Two Press Operation
Access	RW
PDO Mapping	No
Value Range	0 to 7
Default Value	0

3.4.6. Object 2080h: DI Three Press Operation

This object is used to define the operation executed by the Tare Input in calibration mode when pressed three times. The operations can be seen on Table 5.

Object Description

Index	2080h
Name	DI Three Press Operation
Object Type	ARRAY
Data Type	UNSIGNED8

Entry Description

Sub-Index	0h
Description	Largest sub-index supported

Access	RO
PDO Mapping	No
Value Range	1
Default Value	1

Sub-Index	1h
Description	DI Three Press Operation
Access	RW
PDO Mapping	No
Value Range	0 to 7
Default Value	0

3.4.7. Object 2090h: DI Four Press Operation

This object is used to define the operation executed by the Tare Input in calibration mode when pressed four times. The operations can be seen on Table 5.

Object Description

Index	2090h
Name	DI Four Press Operation
Object Type	ARRAY
Data Type	UNSIGNED8

Entry Description

Sub-Index	0h
Description	Largest sub-index supported
Access	RO
PDO Mapping	No
Value Range	1
Default Value	1

Sub-Index	1h
Description	DI Four Press Operation
Access	RW
PDO Mapping	No
Value Range	0 to 7
Default Value	0

3.4.8. Object 20A0h: DI Time Between Presses

This object is used to define the amount of time it in between pressing Tare Input while in calibration mode that will register the inputs as valid consecutive presses.

Object Description

Index	20A0h
Name	DI Time Between Presses
Object Type	ARRAY
Data Type	UNSIGNED8

Entry Description

Sub-Index	0h
Description	Largest sub-index supported
Access	RO
PDO Mapping	No
Value Range	1
Default Value	1

Sub-Index	1h
Description	DI Time Between Presses
Access	RW
PDO Mapping	No
Value Range	0 to 10000
Default Value	1000 [ms]

3.4.9. Object 2100h: SGADC Enabled

This object is used to define whether the Strain Gauge ADC is enabled, this must be on to process any input readings.

Object Description

Index	2100h
Name	SGADC Enabled
Object Type	VAR
Data Type	UNSIGNED8
Access	RW
PDO Mapping	No
Value Range	0 to 1
Default Value	1

3.4.10. Object 2101h: SGADC Digital Filter

This object is used to define the Digital Filter setting for the Strain Gauge ADC.

Object Description

Index	2101h
Name	SGADC Digital Filter
Object Type	VAR
Data Type	UNSIGNED8
Access	RW
PDO Mapping	No
Value Range	0 to 4
Default Value	4

3.4.11. Object 2102h: SGADC Data Rate

This object is used to define the Data Rate setting for the Strain Gauge ADC.

Object Description

Index	2102h
Name	SGADC Data Rate
Object Type	VAR
Data Type	UNSIGNED8
Access	RW
PDO Mapping	No
Value Range	0 to 16
Default Value	4

3.4.12. Object 2103h: SGADC Gain Select

This object is used to define the Gain Select setting for the Strain Gauge ADC.

Object Description

Index	2103h
Name	SGADC Gain Select
Object Type	VAR
Data Type	UNSIGNED8
Access	RW
PDO Mapping	No
Value Range	0 to 7
Default Value	0

3.4.13. Object 2104h: SGADC Burnout Time

This object is used to define the Burnout Time setting for the Strain Gauge ADC. This determines how often the open-wire check is performed.

Object Description

Index	2104h
Name	SGADC Data Rate
Object Type	VAR
Data Type	UNSIGNED16
Access	RW
PDO Mapping	No
Value Range	10 to 50000
Default Value	5000 [ms]

3.4.14. Object 2105h: SGADC Error Detect Enable

This object is used to define whether the errors associated with the Strain Gauge ADC are enabled.

Object Description

Index	2105h
Name	SGADC Gain Select
Object Type	VAR

Data Type	UNSIGNED8
Access	RW
PDO Mapping	No
Value Range	0 to 1
Default Value	0

3.4.15. Object 2106h: SGADC Error React Delay

This object is used to define the error react delay time period for errors associated with the Strain Gauge ADC.

Object Description

Index	2106h
Name	SGADC Data Rate
Object Type	VAR
Data Type	UNSIGNED16
Access	RW
PDO Mapping	No
Value Range	0 to 60,000 [ms]
Default Value	0

3.4.16. Object 2110h: SGIN Weight Units

This object is used to define the weight units used for each Strain Gauge Input.

Object Description

Index	2110h
Name	SGIN Weight Units
Object Type	ARRAY
Data Type	UNSIGNED8

Entry Description

Sub-Index	0h
Description	Largest sub-index supported
Access	RO
PDO Mapping	No
Value Range	4
Default Value	4

Sub-Index	1h to 4h (x = 1 to 4)
Description	SGINx Weight Units
Access	RW
PDO Mapping	No
Value Range	0 to 1
Default Value	0

3.4.17. Object 2111h: SGIN Auto Null

This object is used to trigger the Auto Null function for each Strain Gauge Input.

Object Description

Index	2111h
Name	SGIN Auto Null
Object Type	ARRAY
Data Type	UNSIGNED8

Entry Description

Sub-Index	0h
Description	Largest sub-index supported
Access	RO
PDO Mapping	No
Value Range	4
Default Value	4

Sub-Index	1h to 4h (x = 1 to 4)
Description	SGINx Auto Null
Access	RW
PDO Mapping	No
Value Range	0 to 1
Default Value	0

3.4.18. Object 2112h: SGIN Auto Null Offset

This object is used to read the calibrated offset value of each Strain Gauge Input after an auto null or other calibration operation has been performed.

Object Description

Index	2112h
Name	SGIN Auto Null Offset
Object Type	ARRAY
Data Type	UNSIGNED8

Entry Description

Sub-Index	0h
Description	Largest sub-index supported
Access	RO
PDO Mapping	No
Value Range	4
Default Value	4

Sub-Index	1h to 4h (x = 1 to 4)
Description	SGINx Auto Null Offset
Access	RW
PDO Mapping	No
Default Value	0

3.4.19. Object 2113h: SGIN Rated Weight

This object is used to define the Rated Weight/Maximum Capacity for each Strain Gauge Input.

Object Description

Index	2113h
Name	SGIN Rated Weight
Object Type	ARRAY
Data Type	UNSIGNED32

Entry Description

Sub-Index	0h
Description	Largest sub-index supported
Access	RO
PDO Mapping	No
Value Range	4
Default Value	4

Sub-Index	1h to 4h (x = 1 to 4)
Description	SGINx Rated Weight
Access	RW
PDO Mapping	No
Value Range	0 to 500,000,000
Default Value	136078 [0.1 g or e-4 kg]

3.4.20. Object 2114h: SGIN Sensitivity

This object is used to define the Sensitivity for each Strain Gauge Input.

Object Description

Index	2114h
Name	SGIN Sensitivity
Object Type	ARRAY
Data Type	UNSIGNED32

Entry Description

Sub-Index	0h
Description	Largest sub-index supported
Access	RO
PDO Mapping	No
Value Range	4
Default Value	4

Sub-Index	1h to 4h (x = 1 to 4)
Description	SGINx Sensitivity
Access	RW
PDO Mapping	No
Value Range	0 to 50
Default Value	2 [mV/V]

3.4.21. Object 2115h: SGIN Minimum Range

This object is used to define the Minimum Input Range for each Strain Gauge Input.

Object Description

Index	2115h
Name	SGIN Minimum Range
Object Type	ARRAY
Data Type	UNSIGNED32

Entry Description

Sub-Index	0h
Description	Largest sub-index supported
Access	RO
PDO Mapping	No
Value Range	4
Default Value	4

Sub-Index	1h to 4h (x = 1 to 4)
Description	SGINx Minimum Range
Access	RW
PDO Mapping	No
Default Value	0 [kg]

3.4.22. Object 2116h: SGIN Maximum Range

This object is used to define the Maximum Input Range for each Strain Gauge Input.

Object Description

Index	2116h
Name	SGIN Maximum Range
Object Type	ARRAY
Data Type	UNSIGNED32

Entry Description

Sub-Index	0h
Description	Largest sub-index supported
Access	RO
PDO Mapping	No
Value Range	4
Default Value	4

Sub-Index	1h to 4h (x = 1 to 4)
Description	SGINx Maximum Range
Access	RW
PDO Mapping	No
Default Value	100 [kg]

3.4.23. Object 2117h: SGIN Minimum Error

This object is used to define the Minimum Error Range for each Strain Gauge Input. If a reading is not within the error range, then a fault for that Strain Gauge input will be triggered.

Object Description

Index	2117h
Name	SGIN Minimum Error
Object Type	ARRAY
Data Type	UNSIGNED32

Entry Description

Sub-Index	0h
Description	Largest sub-index supported
Access	RO
PDO Mapping	No
Value Range	4
Default Value	4

Sub-Index	1h to 4h (x = 1 to 4)
Description	SGINx Minimum Error
Access	RW
PDO Mapping	No
Default Value	0 [kg]

3.4.24. Object 2118h: SGIN Maximum Error

This object is used to define the Minimum Error Range for each Strain Gauge Input. If a reading is not within the error range, then a fault for that Strain Gauge input will be triggered.

Object Description

Index	2118h
Name	SGIN Maximum Error
Object Type	ARRAY
Data Type	UNSIGNED32

Entry Description

Sub-Index	0h
Description	Largest sub-index supported
Access	RO
PDO Mapping	No
Value Range	4
Default Value	4

Sub-Index	1h to 4h (x = 1 to 4)
Description	SGINx Maximum Error
Access	RW
PDO Mapping	No
Default Value	90 [kg]

3.4.25. Object 2119h: SGIN Error Detect Enable

This object is used to determine if errors associated with each Strain Gauge Input will occur.

Object Description

Index	2119h
Name	SGIN Error Detect Enable
Object Type	ARRAY
Data Type	UNSIGNED8

Entry Description

Sub-Index	0h
Description	Largest sub-index supported
Access	RO
PDO Mapping	No
Value Range	4
Default Value	4

Sub-Index	1h to 4h
Description	SGINx Error Detect Enable
Access	RW
PDO Mapping	No
Value Range	0 to 1
Default Value	0

3.4.26. Object 211Ah: SGIN Error Clear Hysteresis

This object is used to determine the Hysteresis value used to clear errors associated with each Strain Gauge Input.

Object Description

Index	211Ah
Name	SGIN Error Clear Hysteresis
Object Type	ARRAY
Data Type	UNSIGNED16

Entry Description

Sub-Index	0h
Description	Largest sub-index supported
Access	RO
PDO Mapping	No
Value Range	4
Default Value	4

Sub-Index	1h to 4h (x = 1 to 4)
Description	SGINx Error Clear Hysteresis
Access	RW
PDO Mapping	No

Value Range	
Default Value	200

3.4.27. Object 211Bh: SGIN Error React Delay

This object is used to determine the amount of time after an error is detected until a response occurs for each Strain Gauge Input.

Object Description

Index	211Bh
Name	SGIN Error React Delay
Object Type	ARRAY
Data Type	UNSIGNED16

Entry Description

Sub-Index	0h
Description	Largest sub-index supported
Access	RO
PDO Mapping	No
Value Range	4
Default Value	4

Sub-Index	1h to 4h (x = 1 to 4)
Description	SGINx React Delay
Access	RW
PDO Mapping	No
Value Range	
Default Value	0

3.4.28. Object 211Ch: SGIN Input FV

This object defines the Input Field Value for each Strain Gauge Input.

Object Description

Index	211Ch
Name	SGIN Input FV
Object Type	ARRAY
Data Type	UNSIGNED32

Entry Description

Sub-Index	0h
Description	Largest sub-index supported
Access	RO
PDO Mapping	No
Value Range	4
Default Value	4

Sub-Index	1h to 4h (x = 1 to 4)
Description	SGINx Input FV

Access	RO
PDO Mapping	Yes

3.4.29. Object 211Dh: SGIN mV Input PV

This object defines the mV Input Processed Value for each Strain Gauge Input.

Object Description

Index	211Dh
Name	SGIN mV Input PV
Object Type	ARRAY
Data Type	UNSIGNED32

Entry Description

Sub-Index	0h
Description	Largest sub-index supported
Access	RO
PDO Mapping	No
Value Range	4
Default Value	4

Sub-Index	1h to 4h (x = 1 to 4)
Description	SGINx mV Input PV
Access	RO
PDO Mapping	Yes

3.4.30. Object 211Eh: SGIN Weight Input PV

This object defines the Weight Input Processed Value for each Strain Gauge Input.

Object Description

Index	211Eh
Name	SGIN Weight Input PV
Object Type	ARRAY
Data Type	UNSIGNED32

Entry Description

Sub-Index	0h
Description	Largest sub-index supported
Access	RO
PDO Mapping	No
Value Range	4
Default Value	4

Sub-Index	1h to 4h (x = 1 to 4)
Description	SGINx Weight Input PV
Access	RO
PDO Mapping	Yes

3.4.31. Object 211Fh: SGIN Decimal Digits PV

This object describes the number of digits following the decimal point (i.e. resolution) of the above input data.

Object Description

Index	211Fh
Name	SGIN Decimal Digits PV
Object Type	ARRAY
Data Type	UNSIGNED8

Entry Description

Sub-Index	0h
Description	Largest sub-index supported
Access	RO
PDO Mapping	No
Value Range	4
Default Value	4

Sub-Index	1h to 4h (x = 1 to 4)
Description	SGINx Weight Input PV
Access	RW
PDO Mapping	No
Value Range	0 to 4
Default Value	3

3.4.32. Object 2200h: AO DO Output Type

This object defines how the Analog/Digital Output is configured, as detailed in Section 1.6.

Object Description

Index	2200h
Name	AO DO Output Type
Object Type	ARRAY
Data Type	UNSIGNED8

Entry Description

Sub-Index	0h
Description	Largest sub-index supported
Access	RO
PDO Mapping	No
Value Range	1
Default Value	1

Sub-Index	1h
Description	AO DO Output Type
Access	RW
PDO Mapping	No
Value Range	0 to 4

Default Value	0
---------------	---

3.4.33. Object 2210h: AO DO Control Source

This object defines the Control Source for the Analog/Digital Output.

Object Description

Index	2210h
Name	AO DO Control Source
Object Type	ARRAY
Data Type	UNSIGNED8

Entry Description

Sub-Index	0h
Description	Largest sub-index supported
Access	RO
PDO Mapping	No
Value Range	1
Default Value	1

Sub-Index	1h
Description	AO DO Control Source
Access	RW
PDO Mapping	No
Value Range	0 to 11
Default Value	0

3.4.34. Object 2211h: AO DO Control Number

This object defines the Control Number for the Analog/Digital Output.

Object Description

Index	2211h
Name	AO DO Control Number
Object Type	ARRAY
Data Type	UNSIGNED8

Entry Description

Sub-Index	0h
Description	Largest sub-index supported
Access	RO
PDO Mapping	No
Value Range	1
Default Value	1

Sub-Index	1h
Description	AO DO Control Number
Access	RW
PDO Mapping	No

Value Range	See Table 6
Default Value	1

3.4.35. Object 2230h: DO Logic Type

This object defines the Output Logic Type when the Analog/Digital Output is configured as a Digital Output.

Object Description

Index	2230h
Name	DO Logic Type
Object Type	ARRAY
Data Type	UNSIGNED8

Entry Description

Sub-Index	0h
Description	Largest sub-index supported
Access	RO
PDO Mapping	No
Value Range	1
Default Value	1

Sub-Index	1h
Description	DO Logic Type
Access	RW
PDO Mapping	No
Value Range	0 to 5
Default Value	1

3.4.36. Object 2231h: DO Toggle Frequency

This object defines the Toggle Frequency when the Analog/Digital Output is configured as a Digital Output. This value is only applicable if the Logic Type is set to Toggle.

Object Description

Index	2231h
Name	DO Toggle Frequency
Object Type	ARRAY
Data Type	UNSIGNED16

Entry Description

Sub-Index	0h
Description	Largest sub-index supported
Access	RO
PDO Mapping	No
Value Range	1
Default Value	1

Sub-Index	1h
-----------	----

Description	DO Toggle Frequency
Access	RW
PDO Mapping	No
Value Range	0 to 60,000 [Hz]
Default Value	0

3.4.37. Object 2235h: DO Off State Delay

This object defines the Off State Delay when the Analog/Digital Output is configured as a Digital Output.

Object Description

Index	2235h
Name	DO Off State Delay
Object Type	ARRAY
Data Type	UNSIGNED16

Entry Description

Sub-Index	0h
Description	Largest sub-index supported
Access	RO
PDO Mapping	No
Value Range	1
Default Value	1

Sub-Index	1h
Description	DO Off State Delay
Access	RW
PDO Mapping	No
Value Range	0 to 86,400,000 [ms]
Default Value	0

3.4.38. Object 2236h: DO On State Delay

This object defines the Off State Delay when the Analog/Digital Output is configured as a Digital Output.

Object Description

Index	2236h
Name	DO On State Delay
Object Type	ARRAY
Data Type	UNSIGNED16

Entry Description

Sub-Index	0h
Description	Largest sub-index supported
Access	RO
PDO Mapping	No
Value Range	1

Default Value	1
---------------	---

Sub-Index	1h
Description	DO On State Delay
Access	RW
PDO Mapping	No
Value Range	0 to 86,400,000 [ms]
Default Value	0

3.4.39. Object 2250h: DO Enable Source

This object defines the Enable Source for the Analog/Digital Output when the output is configured as a Digital Output.

Object Description

Index	2250h
Name	DO Enable Source
Object Type	ARRAY
Data Type	UNSIGNED8

Entry Description

Sub-Index	0h
Description	Largest sub-index supported
Access	RO
PDO Mapping	No
Value Range	1
Default Value	1

Sub-Index	1h
Description	DO Enable Source
Access	RW
PDO Mapping	No
Value Range	0 to 11
Default Value	0

3.4.40. Object 2251h: DO Enable Number

This object defines the Enable Number for the Analog/Digital Output when the output is configured as a Digital Output.

Object Description

Index	2251h
Name	DO Enable Number
Object Type	ARRAY
Data Type	UNSIGNED8

Entry Description

Sub-Index	0h
Description	Largest sub-index supported

Access	RO
PDO Mapping	No
Value Range	1
Default Value	1

Sub-Index	1h
Description	DO Enable Number
Access	RW
PDO Mapping	No
Value Range	See Table 6
Default Value	1

3.4.41. Object 2252h: DO Enable Response

This object defines the Enable Response for the Analog/Digital Output when the output is configured as a Digital Output.

Object Description

Index	2252h
Name	DO Enable Response
Object Type	ARRAY
Data Type	UNSIGNED8

Entry Description

Sub-Index	0h
Description	Largest sub-index supported
Access	RO
PDO Mapping	No
Value Range	1
Default Value	1

Sub-Index	1h
Description	DO Enable Response
Access	RW
PDO Mapping	No
Value Range	0 to 5
Default Value	1

3.4.42. Object 2253h: DO Enable Response Delay

This object defines the Enable Response Delay for the Analog/Digital Output when the output is configured as a Digital Output.

Object Description

Index	2253h
Name	DO Enable Response Delay
Object Type	ARRAY
Data Type	UNSIGNED8

Entry Description

Sub-Index	0h
Description	Largest sub-index supported
Access	RO
PDO Mapping	No
Value Range	1
Default Value	1

Sub-Index	1h
Description	DO Enable Response Delay
Access	RW
PDO Mapping	No
Value Range	0 to 1
Default Value	0

3.4.43. Object 2260h: DO Override Source

This object defines the Override Source for the Analog/Digital Output when the output is configured as a Digital Output.

Object Description

Index	2260h
Name	DO Override Source
Object Type	ARRAY
Data Type	UNSIGNED8

Entry Description

Sub-Index	0h
Description	Largest sub-index supported
Access	RO
PDO Mapping	No
Value Range	1
Default Value	1

Sub-Index	1h
Description	DO Override Source
Access	RW
PDO Mapping	No
Value Range	0 to 11
Default Value	0

3.4.44. Object 2261h: DO Override Number

This object defines the Override Number for the Analog/Digital Output when the output is configured as a Digital Output.

Object Description

Index	2261h
Name	DO Override Number

Object Type	ARRAY
Data Type	UNSIGNED8

Entry Description

Sub-Index	0h
Description	Largest sub-index supported
Access	RO
PDO Mapping	No
Value Range	1
Default Value	1

Sub-Index	1h
Description	DO Override Number
Access	RW
PDO Mapping	No
Value Range	See Table 6
Default Value	1

3.4.45. Object 2262h: DO Override Response

This object defines the Override Response for the Analog/Digital Output when the output is configured as a Digital Output.

Object Description

Index	2262h
Name	DO Override Response
Object Type	ARRAY
Data Type	UNSIGNED8

Entry Description

Sub-Index	0h
Description	Largest sub-index supported
Access	RO
PDO Mapping	No
Value Range	1
Default Value	1

Sub-Index	1h
Description	DO Override Response
Access	RW
PDO Mapping	No
Value Range	0 to 1
Default Value	1

3.4.46. Object 2263h: DO Override State

This object defines the Override State for the Analog/Digital Output when the output is configured as a Digital Output.

Object Description

Index	2263h
Name	DO Override State
Object Type	ARRAY
Data Type	UNSIGNED8

Entry Description

Sub-Index	0h
Description	Largest sub-index supported
Access	RO
PDO Mapping	No
Value Range	1
Default Value	1

Sub-Index	1h
Description	DO Override State
Access	RW
PDO Mapping	No
Value Range	0 to 1
Default Value	1

3.4.47. Object 2270h: DO Unlatch Source

This object defines the Unlatch Source for the Analog/Digital Output when the output is configured as a Digital Output.

Object Description

Index	2270h
Name	DO Unlatch Source
Object Type	ARRAY
Data Type	UNSIGNED8

Entry Description

Sub-Index	0h
Description	Largest sub-index supported
Access	RO
PDO Mapping	No
Value Range	1
Default Value	1

Sub-Index	1h
Description	DO Unlatch Source
Access	RW
PDO Mapping	No
Value Range	0 to 11
Default Value	0

3.4.48. Object 2271h: DO Unlatch Number

This object defines the Unlatch Number for the Analog/Digital Output when the output is configured as a Digital Output.

Object Description

Index	2271h
Name	DO Unlatch Number
Object Type	ARRAY
Data Type	UNSIGNED8

Entry Description

Sub-Index	0h
Description	Largest sub-index supported
Access	RO
PDO Mapping	No
Value Range	1
Default Value	1

Sub-Index	1h
Description	DO Override Number
Access	RW
PDO Mapping	No
Value Range	See Table 6
Default Value	1

3.4.49. Object 2310h: AO Error Detect Enable

This object is used to determine if errors associated with the Analog Output will occur.

Object Description

Index	2310h
Name	AO Error Detect Enable
Object Type	ARRAY
Data Type	UNSIGNED8

Entry Description

Sub-Index	0h
Description	Largest sub-index supported
Access	RO
PDO Mapping	No
Value Range	1
Default Value	1

Sub-Index	1h
Description	AO Error Detect Enable
Access	RW
PDO Mapping	No
Value Range	0 to 1

Default Value	0
---------------	---

3.4.50. Object 2311h: AO Error Clear Hysteresis

This object is used to determine the Hysteresis value used to clear errors associated with the Analog Output.

Object Description

Index	2311h
Name	AO Error Clear Hysteresis
Object Type	ARRAY
Data Type	UNSIGNED16

Entry Description

Sub-Index	0h
Description	Largest sub-index supported
Access	RO
PDO Mapping	No
Value Range	1
Default Value	1

Sub-Index	1h
Description	AO Error Clear Hysteresis
Access	RW
PDO Mapping	No
Value Range	
Default Value	200

3.4.51. Object 2312h: AO Error React Delay

This object is used to determine the amount of time after an error is detected until a response occurs for the Analog Output.

Object Description

Index	2312h
Name	AO Error React Delay
Object Type	ARRAY
Data Type	UNSIGNED16

Entry Description

Sub-Index	0h
Description	Largest sub-index supported
Access	RO
PDO Mapping	No
Value Range	1
Default Value	1

Sub-Index	1h
Description	AO React Delay

Access	RW
PDO Mapping	No
Value Range	
Default Value	0

3.4.52. Object 2320h: AO Output Range

This object defines the Output Range, as shown in Table 8, given that the Analog/Digital Output is configured as an Analog Output.

Object Description

Index	2320h
Name	AO Output Range
Object Type	ARRAY
Data Type	UNSIGNED8

Entry Description

Sub-Index	0h
Description	Largest sub-index supported
Access	RO
PDO Mapping	No
Value Range	1
Default Value	1

Sub-Index	1h
Description	AO Output Range
Access	RW
PDO Mapping	No
Value Range	0 to 4
Default Value	0

3.4.53. Object 2321h: AO Slew Rate Control

This object defines the Slew Rate Control, given that the Analog/Digital Output is configured as an Analog Output. Enabling this object allows for the other Slew Rate objects to be used.

Object Description

Index	2321h
Name	AO Slew Rate Control
Object Type	ARRAY
Data Type	UNSIGNED8

Entry Description

Sub-Index	0h
Description	Largest sub-index supported
Access	RO
PDO Mapping	No
Value Range	1
Default Value	1

Sub-Index	1h
Description	AO Slew Rate Control
Access	RW
PDO Mapping	No
Value Range	0 to 1
Default Value	0

3.4.54. Object 2322h: AO Slew Rate Step Options

This object defines the Slew Rate Step Options, given that the Analog/Digital Output is configured as an Analog Output. Refer to Table 9 for further information.

Object Description

Index	2322h
Name	AO Slew Rate Step Options
Object Type	ARRAY
Data Type	UNSIGNED8

Entry Description

Sub-Index	0h
Description	Largest sub-index supported
Access	RO
PDO Mapping	No
Value Range	1
Default Value	1

Sub-Index	1h
Description	AO Slew Rate Step Options
Access	RW
PDO Mapping	No
Value Range	0 to 6
Default Value	0

3.4.55. Object 2323h: AO Slew Rate Clock Options

This object defines the Slew Rate Clock Options, given that the Analog/Digital Output is configured as an Analog Output. Refer to Table 10 for more details.

Object Description

Index	2323h
Name	AO Slew Rate Clock Options
Object Type	ARRAY
Data Type	UNSIGNED8

Entry Description

Sub-Index	0h
Description	Largest sub-index supported
Access	RO

PDO Mapping	No
Value Range	1
Default Value	1

Sub-Index	1h
Description	AO Slew Rate Clock Options
Access	RW
PDO Mapping	No
Value Range	0 to 15
Default Value	0

3.4.56. Object 2380h: AO Output Frequency

This object defines the Output Frequency, given that the Analog/Digital Output is configured as an Analog Output.

Object Description

Index	2380h
Name	AO Output Frequency
Object Type	ARRAY
Data Type	INTEGER16

Entry Description

Sub-Index	0h
Description	Largest sub-index supported
Access	RO
PDO Mapping	No
Value Range	1
Default Value	1

Sub-Index	1h
Description	AO Output Frequency
Access	RW
PDO Mapping	No
Value Range	0 to 25,000 [Hz]
Default Value	0

3.4.57. Object 2400h: RLY Output Type

This object defines how the Interlock Output is configured, as detailed in Section 1.6.

Object Description

Index	2400h
Name	RLY Output Type
Object Type	ARRAY
Data Type	UNSIGNED8

Entry Description

Sub-Index	0h
-----------	----

Description	Largest sub-index supported
Access	RO
PDO Mapping	No
Value Range	1
Default Value	1

Sub-Index	1h
Description	RLY Output Type
Access	RW
PDO Mapping	No
Value Range	0 to 4
Default Value	0

3.4.58. Object 2401h: RLY Logic Type

This object defines the Logic Type for the Interlock/Relay Output.

Object Description

Index	2401h
Name	RLY Logic Type
Object Type	ARRAY
Data Type	UNSIGNED8

Entry Description

Sub-Index	0h
Description	Largest sub-index supported
Access	RO
PDO Mapping	No
Value Range	1
Default Value	1

Sub-Index	1h
Description	RLY Logic Type
Access	RW
PDO Mapping	No
Value Range	0 to 5
Default Value	1

3.4.59. Object 2402h: RLY Toggle Frequency

This object defines the Toggle Frequency for the Interlock/Relay Output. This value is only applicable if the Logic Type is set to Toggle.

Object Description

Index	2402h
Name	RLY Toggle Frequency
Object Type	ARRAY
Data Type	UNSIGNED16

Entry Description

Sub-Index	0h
Description	Largest sub-index supported
Access	RO
PDO Mapping	No
Value Range	1
Default Value	1

Sub-Index	1h
Description	RLY Toggle Frequency
Access	RW
PDO Mapping	No
Value Range	0 to 60,000 [Hz]
Default Value	0

3.4.60. Object 2405h: RLY Off State Delay

This object defines the Off State Delay for the Interlock/Relay Output.

Object Description

Index	2405h
Name	RLY Off State Delay
Object Type	ARRAY
Data Type	UNSIGNED16

Entry Description

Sub-Index	0h
Description	Largest sub-index supported
Access	RO
PDO Mapping	No
Value Range	1
Default Value	1

Sub-Index	1h
Description	RLY Off State Delay
Access	RW
PDO Mapping	No
Value Range	0 to 86,400,000 [ms]
Default Value	0

3.4.61. Object 2406h: RLY On State Delay

This object defines the Off State Delay for the Interlock/Relay Output.

Object Description

Index	2406h
Name	RLY On State Delay
Object Type	ARRAY
Data Type	UNSIGNED16

Entry Description

Sub-Index	0h
Description	Largest sub-index supported
Access	RO
PDO Mapping	No
Value Range	1
Default Value	1

Sub-Index	1h
Description	RLY On State Delay
Access	RW
PDO Mapping	No
Value Range	0 to 86,400,000 [ms]
Default Value	0

3.4.62. Object 2407h: RLY Write State

This object defines the Write State for the Interlock/Relay Output.

Object Description

Index	2407h
Name	RLY Write State
Object Type	ARRAY
Data Type	UNSIGNED8

Entry Description

Sub-Index	0h
Description	Largest sub-index supported
Access	RO
PDO Mapping	No
Value Range	1
Default Value	1

Sub-Index	1h
Description	RLY Write State
Access	RW
PDO Mapping	Yes

3.4.63. Object 2410h: RLY Control Source

This object defines the Control Source for the Interlock/Relay Output.

Object Description

Index	2410h
Name	RLY Control Source
Object Type	ARRAY
Data Type	UNSIGNED8

Entry Description

Sub-Index	0h
Description	Largest sub-index supported
Access	RO
PDO Mapping	No
Value Range	1
Default Value	1

Sub-Index	1h
Description	RLY Control Source
Access	RW
PDO Mapping	No
Value Range	0 to 11
Default Value	0

3.4.64. Object 2411h: RLY Control Number

This object defines the Enable Number for the Interlock/Relay Output.

Object Description

Index	2411h
Name	RLY Control Number
Object Type	ARRAY
Data Type	UNSIGNED8

Entry Description

Sub-Index	0h
Description	Largest sub-index supported
Access	RO
PDO Mapping	No
Value Range	1
Default Value	1

Sub-Index	1h
Description	RLY Control Number
Access	RW
PDO Mapping	No
Value Range	See Table 6
Default Value	1

3.4.65. Object 2420h: RLY Enable Source

This object defines the Enable Source for the Interlock/Relay Output.

Object Description

Index	2420h
Name	RLY Enable Source

Object Type	ARRAY
Data Type	UNSIGNED8

Entry Description

Sub-Index	0h
Description	Largest sub-index supported
Access	RO
PDO Mapping	No
Value Range	1
Default Value	1

Sub-Index	1h
Description	RLY Enable Source
Access	RW
PDO Mapping	No
Value Range	0 to 11
Default Value	0

3.4.66. Object 2421h: RLY Enable Number

This object defines the Enable Number for the Interlock/Relay Output.

Object Description

Index	2421h
Name	RLY Enable Number
Object Type	ARRAY
Data Type	UNSIGNED8

Entry Description

Sub-Index	0h
Description	Largest sub-index supported
Access	RO
PDO Mapping	No
Value Range	1
Default Value	1

Sub-Index	1h
Description	RLY Enable Number
Access	RW
PDO Mapping	No
Value Range	See Table 6
Default Value	1

3.4.67. Object 2422h: RLY Enable Response

This object defines the Enable Response for the Interlock/Relay Output.

Object Description

Index	2422h
Name	RLY Enable Response
Object Type	ARRAY
Data Type	UNSIGNED8

Entry Description

Sub-Index	0h
Description	Largest sub-index supported
Access	RO
PDO Mapping	No
Value Range	1
Default Value	1

Sub-Index	1h
Description	RLY Enable Response
Access	RW
PDO Mapping	No
Value Range	0 to 5
Default Value	1

3.4.68. Object 2423h: RLY Enable Response Delay

This object defines the Enable Response Delay for the Interlock/Relay Output.

Object Description

Index	2423h
Name	RLY Enable Response Delay
Object Type	ARRAY
Data Type	UNSIGNED8

Entry Description

Sub-Index	0h
Description	Largest sub-index supported
Access	RO
PDO Mapping	No
Value Range	1
Default Value	1

Sub-Index	1h
Description	RLY Enable Response Delay
Access	RW
PDO Mapping	No
Value Range	0 to 1
Default Value	0

3.4.69. Object 2430h: RLY Override Source

This object defines the Override Source for the Interlock/Relay Output.

Object Description

Index	2430h
Name	RLY Override Source
Object Type	ARRAY
Data Type	UNSIGNED8

Entry Description

Sub-Index	0h
Description	Largest sub-index supported
Access	RO
PDO Mapping	No
Value Range	1
Default Value	1

Sub-Index	1h
Description	RLY Override Source
Access	RW
PDO Mapping	No
Value Range	0 to 11
Default Value	0

3.4.70. Object 2431h: RLY Override Number

This object defines the Override Number for the Interlock/Relay Output.

Object Description

Index	2431h
Name	RLY Override Number
Object Type	ARRAY
Data Type	UNSIGNED8

Entry Description

Sub-Index	0h
Description	Largest sub-index supported
Access	RO
PDO Mapping	No
Value Range	1
Default Value	1

Sub-Index	1h
Description	RLY Override Number
Access	RW
PDO Mapping	No
Value Range	See Table 6
Default Value	1

3.4.71. Object 2432h: RLY Override Response

This object defines the Override Response for the Interlock/Relay Output.

Object Description

Index	2432h
Name	RLY Override Response
Object Type	ARRAY
Data Type	UNSIGNED8

Entry Description

Sub-Index	0h
Description	Largest sub-index supported
Access	RO
PDO Mapping	No
Value Range	1
Default Value	1

Sub-Index	1h
Description	RLY Override Response
Access	RW
PDO Mapping	No
Value Range	0 to 1
Default Value	1

3.4.72. Object 2433h: RLY Override State

This object defines the Override State for the Interlock/Relay Output.

Object Description

Index	2433h
Name	RLY Override State
Object Type	ARRAY
Data Type	UNSIGNED8

Entry Description

Sub-Index	0h
Description	Largest sub-index supported
Access	RO
PDO Mapping	No
Value Range	1
Default Value	1

Sub-Index	1h
Description	RLY Override State
Access	RW
PDO Mapping	No
Value Range	0 to 1
Default Value	1

3.4.73. Object 2440h: RLY Unlatch Source

This object defines the Unlatch Source for the Interlock/Relay Output.

Object Description

Index	2440h
Name	RLY Unlatch Source
Object Type	ARRAY
Data Type	UNSIGNED8

Entry Description

Sub-Index	0h
Description	Largest sub-index supported
Access	RO
PDO Mapping	No
Value Range	1
Default Value	1

Sub-Index	1h
Description	RLY Unlatch Source
Access	RW
PDO Mapping	No
Value Range	0 to 11
Default Value	0

3.4.74. Object 2441h: RLY Unlatch Number

This object defines the Unlatch Number for the Interlock/Relay Output.

Object Description

Index	2441h
Name	RLY Unlatch Number
Object Type	ARRAY
Data Type	UNSIGNED8

Entry Description

Sub-Index	0h
Description	Largest sub-index supported
Access	RO
PDO Mapping	No
Value Range	1
Default Value	1

Sub-Index	1h
Description	RLY Override Number
Access	RW
PDO Mapping	No
Value Range	See Table 6
Default Value	1

3.4.75. Object 2500h: EC Extra Received Process Value

This object provides an extra control source, in order to allow other function blocks to be controlled by data received from a CANopen® RPDO. It functions similarly to any other writeable, mappable PV object, such as 7300h AO Output PV.

Object Description

Index	2500h
Name	EC Extra Received Process Value
Object Type	ARRAY
Data Type	INTEGER16

Entry Description

Sub-Index	0h
Description	Largest sub-index supported
Access	RO
PDO Mapping	No
Value Range	14
Default Value	14

Sub-Index	1h to 14h (x = 1 to 14)
Description	ECx Received Process Value
Access	RW
PDO Mapping	Yes
Value Range	Integer16
Default Value	No

3.4.76. Object 2502h: EC Decimal Digits PV

This object describes the number of digits following the decimal point (i.e. resolution) of the extra control data, which is interpreted with data type Integer16 in the process value object.

Object Description

Index	2502h
Name	EC Decimal Digits PV
Object Type	ARRAY
Data Type	UNSIGNED8

Entry Description

Sub-Index	0h
Description	Largest sub-index supported
Access	RO
PDO Mapping	No
Value Range	14
Default Value	14

Sub-Index	1h to 14h (x = 1 to 14)
Description	ECx Decimal Digits PV
Access	RW
PDO Mapping	No

Value Range	0 to 4
Default Value	1 (0.1 resolution)

3.4.77. Object 2520h: EC Scaling 1 PV

This object defines the minimum value of the extra control source. It is used as the Scaling 1 value by other functions blocks when the EC has been selected as the source for the X-Axis data. There is no physical unit associated with the data, but it uses the same resolution as the received PV as defined in object 2502h, EC Decimal Digits PV. This object must always be smaller than object 2522h EC Scaling 2 PV.

Object Description

Index	2520h
Name	EC Scaling 1 PV
Object Type	ARRAY
Data Type	INTEGER16

Entry Description

Sub-Index	0h
Description	Largest sub-index supported
Access	RO
PDO Mapping	No
Value Range	14
Default Value	14

Sub-Index	1h to 14h (x = 1 to 14)
Description	ECx Scaling 1 PV
Access	RW
PDO Mapping	No
Value Range	-32768 to 2522h sub-index X
Default Value	0

3.4.78. Object 2522h: EC Scaling 2 PV

This object defines the maximum value of the extra control source. It is used as the Scaling 2 value by other functions blocks when the EC has been selected as the source for the X-Axis data, i.e. as seen in Figure 5. There is no physical unit associated with the data, but it uses the same resolution as the received PV as defined in object 2502h, EC Decimal Digits PV. This object must always be larger than object 2520h EC Scaling 1 PV.

Object Description

Index	2522h
Name	EC Scaling 2 PV
Object Type	ARRAY
Data Type	INTEGER16

Entry Description

Sub-Index	0h
Description	Largest sub-index supported
Access	RO

PDO Mapping	No
Value Range	14
Default Value	14

Sub-Index	1h to 14h (x = 1 to 14)
Description	ECx Scaling 2 PV
Access	RW
PDO Mapping	No
Value Range	2520h sub-index X to 32767
Default Value	1000 (100.0)

3.4.79. Object 2600h: CAN Tare

This object defines the CAN Tare values. The object contains 2 different mappable sub objects which can be used to perform different calibration operations for the Strain Gauge Inputs. By default, the RPDO's are setup to map input data to this object. Refer to Section 1.8 for more information.

Object Description

Index	2600h
Name	CAN Tare
Object Type	ARRAY
Data Type	UNSIGNED8

Entry Description

Sub-Index	0h
Description	Largest sub-index supported
Access	RO
PDO Mapping	No
Value Range	3
Default Value	3

Sub-Index	1h
Description	CAN Tare Command
Access	RW
PDO Mapping	Yes

Sub-Index	2h
Description	CAN Tare Operation
Access	RW
PDO Mapping	Yes

Sub-Index	3h
Description	CAN Tare Status
Access	RO
PDO Mapping	No

3.4.80. Object 5010h: Constant Field Value

This object is provided to allow the user to compare against a fixed value. The first two values in this object are fixed at FALSE (0) and TRUE (1).

Object Description

Index	5010h
Name	Constant Field Value
Object Type	ARRAY
Data Type	FLOAT32

Entry Description

Sub-Index	0
Description	Largest sub-index supported
Access	RO
PDO Mapping	No
Value Range	15
Default Value	15

Sub-Index	1
Description	Constant False
Access	RO
PDO Mapping	No
Value Range	0
Default Value	0 (false)

Sub-Index	2
Description	Constant True
Access	RO
PDO Mapping	No
Value Range	1
Default Value	1 (true)

Sub-Index	3
Description	Constant FV 3
Access	RW
PDO Mapping	No
Value Range	Float32
Default Value	3.141593

Sub-Index	4
Description	Constant FV 4
Access	RW
PDO Mapping	No
Value Range	Float32
Default Value	2.718282

Sub-Index	5
Description	Constant FV 5
Access	RW
PDO Mapping	No
Value Range	Float32
Default Value	1.414214

Sub-Index	6
Description	Constant FV 6
Access	RW
PDO Mapping	No
Value Range	Float32
Default Value	1.732051

Sub-Index	7
Description	Constant FV 7
Access	RW
PDO Mapping	No
Value Range	Float32
Default Value	2.236068

Sub-Index	8
Description	Constant FV 8
Access	RW
PDO Mapping	No
Value Range	Float32
Default Value	2.50

Sub-Index	9
Description	Constant FV 9
Access	RW
PDO Mapping	No
Value Range	Float32
Default Value	5.00

Sub-Index	10
Description	Constant FV 10
Access	RW
PDO Mapping	No
Value Range	Float32
Default Value	10.00

Sub-Index	11
Description	Constant FV 11
Access	RW
PDO Mapping	No
Value Range	Float32
Default Value	20.00

Sub-Index	12
Description	Constant FV 12
Access	RW
PDO Mapping	No
Value Range	Float32
Default Value	40.00

Sub-Index	13
-----------	----

Description	Constant FV 13
Access	RW
PDO Mapping	No
Value Range	Float32
Default Value	60.00

Sub-Index	14
Description	Constant FV 14
Access	RW
PDO Mapping	No
Value Range	Float32
Default Value	80.00

Sub-Index	15
Description	Constant FV 15
Access	RW
PDO Mapping	No
Value Range	Float32
Default Value	1000.00

3.4.81. Object 5020h: Power Supply Field Value

This read-only object is available for diagnostic feedback purposes. It reflects the measured voltage powering the controller. The physical unit for this object is volts.

Object Description

Index	5020h
Name	Power Supply Field Value
Object Type	VARIABLE
Data Type	FLOAT32

Entry Description

Sub-Index	0h
Access	RO
PDO Mapping	Yes
Value Range	0 to 70 [V]
Default Value	No

3.4.82. Object 5030h: Processor Temperature Field Value

This read-only object is available for diagnostic feedback purposes. It reflects the measured processor temperature of the controller. The physical unit for this object is Celsius.

Object Description

Index	5030h
Name	Processor Temperature Field Value
Object Type	VARIABLE
Data Type	FLOAT32

Entry Description

Sub-Index	0h
Access	RO
PDO Mapping	Yes
Value Range	-50 to 150 [DegC]
Default Value	No

3.4.83. Object 5550h: Enable Automatic Updates

This object allows the controller to update objects to defaults automatically when an output type is changed. By default this object is TRUE.

Object Description

Index	5550h
Name	Enable Auto Updates
Object Type	VARIABLE
Data Type	BOOLEAN

Entry Description

Sub-Index	0h
Access	RW
PDO Mapping	No
Value Range	0 (FALSE) or 1 (TRUE)
Default Value	1 [TRUE]

3.4.84. Object 5555h: Start in Operational Mode

This object allows the unit to start in Operational mode without requiring the presence of a CANopen® Master on the network. It is intended to be used only when running the controller as a stand-alone module. This should always be set FALSE whenever it is connected to a standard master/slave network.

Object Description

Index	5555h
Name	Start in Operational Mode
Object Type	VARIABLE
Data Type	BOOLEAN

Entry Description

Sub-Index	0h
Access	RW
PDO Mapping	No
Value Range	0 (FALSE) or 1 (TRUE)
Default Value	0 [FALSE]

3.5. LOGIC OBJECTS

<i>Index (hex)</i>	<i>Object</i>	<i>Object Type</i>	<i>Data Type</i>	<i>Access</i>	<i>PDO Mapping</i>
-------------------------------	----------------------	-------------------------------	-------------------------	----------------------	-------------------------------

30y0	Lookup Table y Input X-Axis Source	VAR	UNSIGNED8	RW	No
30y1	Lookup Table y Input X-Axis Number	VAR	UNSIGNED8	RW	No
30y2	Lookup Table y Auto Repeat	VAR	UNSIGNED8	RW	No
30y3	Lookup Table y X-Axis Decimal Digits PV	VAR	UNSIGNED8	RW	No
30y4	Lookup Table y Y-Axis Decimal Digits PV	VAR	UNSIGNED8	RW	No
30y5	Lookup Table y Point Response	ARRAY	UNSIGNED8	RW	No
30y6	Lookup Table y X-Axis PV	ARRAY	INTEGER32	RW	No
30y7	Lookup Table y Y-Axis PV	ARRAY	INTEGER16	RW	No
30y8	Lookup Table y Output Y-Axis PV	VAR	INTEGER16	RO	Yes
30y9	Lookup Table y Table Type	VAR	UNSIGNED8	RW	No
3300	Logic Block Enable	ARRAY	BOOLEAN	RW	No
3310	Logic Block Selected Table	ARRAY	UNSIGNED8	RO	Yes
3320	Logic Output Process Value	ARRAY	INTEGER16	RO	Yes
3x01	LB(3-x) Lookup Table Number	ARRAY	UNSIGNED8	RW	No
3x02	LB(3-x) Function Logical Operator	ARRAY	UNSIGNED8	RW	No
3x11	LB(3-x) Function A Condition 1	RECORD	UNSIGNED8	RW	No
3x12	LB(3-x) Function A Condition 2	RECORD	UNSIGNED8	RW	No
3x13	LB(3-x) Function A Condition 3	RECORD	UNSIGNED8	RW	No
3x21	LB(3-x) Function B Condition 1	RECORD	UNSIGNED8	RW	No
3x22	LB(3-x) Function B Condition 2	RECORD	UNSIGNED8	RW	No
3x23	LB(3-x) Function B Condition 3	RECORD	UNSIGNED8	RW	No
3x31	LB(3-x) Function C Condition 1	RECORD	UNSIGNED8	RW	No
3x32	LB(3-x) Function C Condition 2	RECORD	UNSIGNED8	RW	No
3x33	LB(3-x) Function C Condition 3	RECORD	UNSIGNED8	RW	No
4000	Math Block Enable	ARRAY	BOOLEAN	RW	No
4021	Math Output Scaling 1 PV	ARRAY	INTEGER16	RW	No
4023	Math Output Scaling 2 PV	ARRAY	INTEGER16	RW	No
4030	Math Output Process Value	ARRAY	INTEGER16	RO	Yes
4032	Math Output Decimal Digits PV	ARRAY	UNSIGNED8	RW	No
4y00	Math Y Input Source	ARRAY	UNSIGNED8	RW	No
4y01	Math Y Input Number	ARRAY	UNSIGNED8	RW	No
4y02	Math Y Function Number	ARRAY	UNSIGNED8	RW	No
4y03	Math Y Input Decimal Digits FV	ARRAY	UNSIGNED8	RW	No
4y20	Math Y Input Scaling 1 FV	ARRAY	INTEGER16	RW	No
4y22	Math Y Input Scaling 2 FV	ARRAY	INTEGER16	RW	No
4y40	Math Y Input Gain	ARRAY	INTEGER8	RW	No
4y50	Math Y Operator	ARRAY	UNSIGNED8	RW	No
4500	COND LOGIC Enabled	ARRAY	UNSIGNED8	RW	No
4501	COND LOGIC Output PV	ARRAY	UNSIGNED8	RO	Yes
4x10	COND LOGIC x Result Operator	RECORD	UNSIGNED8	RW	No
4x20	COND LOGIC x Condition 1	RECORD	UNSIGNED8	RW	No
4x25	COND LOGIC x Condition 2	RECORD	UNSIGNED8	RW	No
4Fy0	SRL y Enabled	VAR	UNSIGNED8	RW	No
4Fy1	SRL y Set Control Source	VAR	UNSIGNED8	RW	No
4Fy2	SRL y Set Control Number	VAR	UNSIGNED8	RW	No
4Fy3	SRL y Reset Control Source	VAR	UNSIGNED8	RW	No
4Fy4	SRL y Reset Control Number	VAR	UNSIGNED8	RW	No
4Fy5	SRL y Set Input On Percent	VAR	UNSIGNED16	RW	No
4Fy6	SRL y Reset Input On Percent	VAR	UNSIGNED16	RW	No
4Fy7	SRL y Set Input Off Percent	VAR	UNSIGNED16	RW	No
4Fy8	SRL y Reset Input Off Percent	VAR	UNSIGNED16	RW	No
4Fy9	SRL y Output PV	VAR	UNSIGNED8	RW	No

3.5.1. Object 30y0h: Lookup Table y Input X-Axis Source

This object defines the type of input that will be used to determine the X-Axis input process value for the lookup table function. Not all sources would make sense to use as an X-Axis input, and it is the user's responsibility to select a source that makes sense for the application. A selection of "Control Source Not Used" disables the associated lookup table function block.

Object Description

Index	30y0h (where y = 1 to 6)
Name	Lookup Table y Input X-Axis Source
Object Type	VARIABLE
Data Type	UNSIGNED8

Entry Description

Sub-Index	0h
Access	RW
PDO Mapping	No
Value Range	0 to 11
Default Value	0 (control not used)

3.5.2. Object 30y1h: Lookup Table y Input X-Axis Number

This object defines the number of the source that will be used as the X-Axis input PV for the lookup table function. The available control numbers are dependent on the source selected. Once selected, the limits for the points on the X-Axis will be constrained by the scaling objects of the control source/number.

Object Description

Index	30y1h (where y = 1 to 6)
Name	Lookup Table y Input X-Axis Number
Object Type	VARIABLE
Data Type	UNSIGNED8

Entry Description

Sub-Index	0h
Access	RW
PDO Mapping	No
Value Range	See Table 6
Default Value	1

3.5.3. Object 30y2h: Lookup Table y Auto Repeat

This object determines whether the lookup table sequence will repeat automatically once the last point in the lookup table has been completed. This object is only taken into effect when the response is set to 'Time Response'. For more details on the functionality of this object and its effect on the lookup table, please refer to Section 1.9.5.

Object Description

Index	30y2h (where y = 1 to 6)
-------	--------------------------

Name	Lookup Table y X-Axis Auto Repeat
Object Type	VARIABLE
Data Type	UNSIGNED8

Entry Description

Sub-Index	0h
Access	RW
PDO Mapping	No
Value Range	0 (OFF) to 1 (ON)
Default Value	0 [OFF]

3.5.4. Object 30y3h: Lookup Table y X-Axis Decimal Digits PV

This object describes the number of digits following the decimal point (i.e. resolution) of the X-Axis input data and the points in the lookup table. It should be set equal to the decimal digits used by the PV from the control source/number.

Object Description

Index	30y3h (where y = 1 to 6)
Name	Lookup Table y X-Axis Decimal Digits PV
Object Type	VARIABLE
Data Type	UNSIGNED8

Entry Description

Sub-Index	0h
Access	RW
PDO Mapping	No
Value Range	0 to 4 (see Table 6)
Default Value	0

3.5.5. Object 30y4h: Lookup Table y Y-Axis Decimal Digits PV

This object describes the number of digits following the decimal point (i.e. resolution) of the Y-Axis points in the lookup table. When the Y-Axis output is going to be the input to another function block (i.e. an analog output), it is recommended that this value be set equal to the decimal digits used by the block that is using the lookup table as the control source/number.

Object Description

Index	30y4h (where y = 1 to 6)
Name	Lookup Table y Y-Axis Decimal Digits PV
Object Type	VARIABLE
Data Type	UNSIGNED8

Entry Description

Sub-Index	0h
Access	RW
PDO Mapping	No
Value Range	0 to 4
Default Value	0

3.5.6. Object 30y5h: Lookup Table y Point Response

This object determines the Y-Axis output response to changes in the X-Axis input. The value set in sub-index 1 determines the X-Axis type (i.e. data or time), while all other sub-indexes determine the response (ramp, step, ignore) between two points on the curve.

Object Description

Index	30y5h (where y = 1 to 6)
Name	Lookup Table y Point Response
Object Type	ARRAY
Data Type	UNSIGNED8

Entry Description

Sub-Index	0h
Description	Largest sub-index supported
Access	RO
PDO Mapping	No
Value Range	11
Default Value	11

Sub-Index	1h
Description	X-Axis Type
Access	RW
PDO Mapping	No
Value Range	See Table 12 (0 or 1)
Default Value	0 (x-axis data response)

Sub-Index	2h to 11h (x = 2 to 11)
Description	Lookup Table y Point X Response
Access	RW
PDO Mapping	No
Value Range	See Table 12 (0, 1 or 2)
Default Value	1 (ramp to response)

3.5.7. Object 30y6h: Lookup Table y Point X-Axis PV

This object defines the X-Axis data for the 11 calibration points on the lookup table, resulting in 10 different output slopes.

When a data response is selected for the X-Axis type (sub-index 1 of object 3yz5), this object is constrained such that X1 cannot be less than the Scaling 1 value of the selected control source/number, and X11 cannot be more than the Scaling 2 value. The rest of the points are constrained by the formula below. The physical unit associate with the data will be that of the selected input, and it will use the resolution defined in object 3yz3h, Lookup Table y X-Axis Decimal Digits PV.

$$\text{MinInt16} \leq X_1 \leq X_2 \leq X_3 \leq X_4 \leq X_5 \leq X_6 \leq X_7 \leq X_8 \leq X_9 \leq X_{10} \leq X_{11} \leq \text{MaxInt16}$$

When a time response has been selected, each point on the X-Axis can be set anywhere from 1 to 86,400,000ms.

Object Description

Index	30y6h (where y = 1 to 6)
Name	Lookup Table y Point X-Axis PV
Object Type	ARRAY
Data Type	INTEGER32

Entry Description

Sub-Index	0h
Description	Largest sub-index supported
Access	RO
PDO Mapping	No
Value Range	11
Default Value	11

Sub-Index	1h to 11h (x = 1 to 11)
Description	Lookup Table y Point X-Axis PV _x
Access	RW
PDO Mapping	No
Value Range	See above (data) 1 to 86400000 (time)
Default Value	10 ^{*(x-1)} No

3.5.8. Object 30y7h: Lookup Table y Point Y-Axis PV

This object defines the Y-Axis data for the 11 calibration points on the lookup table, resulting in 10 different output slopes. The data is unconstrained and has no physical unit associate with it. It will use the resolution defined in object 30y4h, Lookup Table y Y-Axis Decimal Digits PV.

Object Description

Index	30y7h (where y = 1 to 6)
Name	Lookup Table y Point Y-Axis PV
Object Type	ARRAY
Data Type	INTEGER16

Entry Description

Sub-Index	0h
Description	Largest sub-index supported
Access	RO
PDO Mapping	No
Value Range	11
Default Value	11

Sub-Index	1h to 11h (x = 1 to 11)
Description	LTyz Point Y-Axis PV _x
Access	RW
PDO Mapping	No
Value Range	Integer16
Default Value	10 ^{*(x-1)} [i.e. 0, 10, 20, 30, ... 100]

3.5.9. Object 30y8h: Lookup Table y Output Y-Axis PV

This read-only object contains the lookup table function block PV that can be used as the input source for another function block (i.e. analog output.) The physical unit for this object is undefined, and it will use the resolution defined in object 30y4h, Lookup Table y Y-Axis Decimal Digits PV.

Object Description

Index	30y8h (where y = 1 to 6)
Name	Lookup Table y Output Y-Axis PV
Object Type	VARIABLE
Data Type	INTEGER16

Entry Description

Sub-Index	0h
Access	RO
PDO Mapping	Yes
Value Range	Integer16
Default Value	No

3.5.10. Object 3300h: Logic Block Enable

This object defines whether or not each Logic Block will be evaluated.

Object Description

Index	3300h
Name	Logic Block Enable
Object Type	ARRAY
Data Type	BOOLEAN

Entry Description

Sub-Index	0h
Description	Largest sub-index supported
Access	RO
PDO Mapping	No
Value Range	2
Default Value	2

Sub-Index	1h to 2h (x = 1 to 2)
Description	Logic Block x Enable
Access	RW
PDO Mapping	No
Value Range	0 (FALSE) or 1 (TRUE)
Default Value	0 [FALSE]

3.5.11. Object 3310h: Logic Block Selected Table

This read-only object reflects what table has been selected as the output source for the logic block after the evaluation has been performed.

Object Description

Index	3310h
Name	Logic Block Selected Table
Object Type	ARRAY
Data Type	UNSIGNED8

Entry Description

Sub-Index	0h
Description	Largest sub-index supported
Access	RO
PDO Mapping	No
Value Range	2
Default Value	2

Sub-Index	1h to 2h (x = 1 to 2)
Description	Logic Block x Selected Table
Access	RO
PDO Mapping	Yes
Value Range	1 to 6
Default Value	No

3.5.12. Object 3320h: Logic Block Output PV

This read-only object reflects the output from the selected table, interpreted as a percentage. The limits for the percentage conversion are based on the range of the lookup tables Y-Axis Output PV. This value has a fixed decimal digit value of 1 giving a resolution of 0.1%.

Object Description

Index	3320h
Name	Logic Block Output PV
Object Type	ARRAY
Data Type	UNSIGNED8

Entry Description

Sub-Index	0h
Description	Largest sub-index supported
Access	RO
PDO Mapping	No
Value Range	4
Default Value	4

Sub-Index	1h to 4h (x = 1 to 4)
Description	Logic Block x Output PV
Access	RO
PDO Mapping	Yes
Value Range	Dependent on Selected Table
Default Value	No

3.5.13. Object 3x01h: Logic Block (x-3) Lookup Table Numbers

This object determines which of the six lookup tables are associated with a particular function within the given logic block. Up to three tables can be linked to each logic function.

Object Description

Index	3x01h (where x = 4 to 5)
Name	Logic Block (x-3) Lookup Table Numbers
Object Type	ARRAY
Data Type	UNSIGNED8

Entry Description

Sub-Index	0h
Description	Largest sub-index supported
Access	RO
PDO Mapping	No
Value Range	4
Default Value	4

Sub-Index	1h to 3h (y = 1 to 3)
Description	Logic Block (x-3) Lookup Table Y Number
Access	RW
PDO Mapping	No
Value Range	1 to 12
Default Value	See Table 18

3.5.14. Object 3x02h: Logic Block (x-3) Function Logical Operator

This object determines how the results of the three conditions for each function are to be compared to one another to determine the overall state of the function output. There are up to three functions that can be evaluated in each logic block.

Object Description

Index	3x02h (where x = 4 to 5)
Name	Logic Block (x-3) Function Logical Operator
Object Type	ARRAY
Data Type	UNSIGNED8

Entry Description

Sub-Index	0h
Description	Largest sub-index supported
Access	RO
PDO Mapping	No
Value Range	4
Default Value	4

Sub-Index	1h to 3h (y = A to C)
Description	Logic Block (x-3) Function Y Logical Operator

Access	RW
PDO Mapping	No
Value Range	See Table 5
Default Value	Function A = 1 (and all) Function B = 1 (and all) Function C = 0 (default)

- 3.5.15. Object 3x11h: Logic Block (x-3) Function A Condition 1
- 3.5.16. Object 3x12h: Logic Block (x-3) Function A Condition 2
- 3.5.17. Object 3x13h: Logic Block (x-3) Function A Condition 3
- 3.5.18. Object 3x21h: Logic Block (x-3) Function B Condition 1
- 3.5.19. Object 3x22h: Logic Block (x-3) Function B Condition 2
- 3.5.20. Object 3x23h: Logic Block (x-3) Function B Condition 3
- 3.5.21. Object 3x31h: Logic Block (x-3) Function C Condition 1
- 3.5.22. Object 3x32h: Logic Block (x-3) Function C Condition 2
- 3.5.23. Object 3x33h: Logic Block (x-3) Function C Condition 3

These objects, 3xyzh, represent Logic Block z, Function y, Condition z, where x = 4 to 7, y = 1 (A) to 3 (C), and z = 1 to 3. All of these objects are a special type of record.

Object Description

Index	3xyzh
Name	Logic Block (x-3) Function y Condition z
Object Type	RECORD
Data Type	UNSIGNED8

Entry Description

Sub-Index	0h
Description	Largest sub-index supported
Access	RO
PDO Mapping	No
Value Range	5
Default Value	5

Sub-Index	1h
Description	Argument 1 Source
Access	RW
PDO Mapping	No
Value Range	0 to 11
Default Value	0

Sub-Index	2h
Description	Argument 1 Number
Access	RW
PDO Mapping	No
Value Range	See Table 6
Default Value	1

Sub-Index	3h
-----------	----

Description	Argument 2 Source
Access	RW
PDO Mapping	No
Value Range	0 to 11
Default Value	0

Sub-Index	4h
Description	Argument 2 Number
Access	RW
PDO Mapping	No
Value Range	See Table 6
Default Value	1

Sub-Index	5h
Description	Operator
Access	RW
PDO Mapping	No
Value Range	0 to 5
Default Value	0 (Equals)

3.5.24. Object 4000h: Math Function Enable

The corresponding sub-index of object must be set TRUE in order for a math function block to be enabled. Otherwise, the output will always be at 0.

Object Description

Index	4000h
Name	Math Function Enable
Object Type	ARRAY
Data Type	BOOLEAN

Entry Description

Sub-Index	0h
Description	Largest sub-index supported
Access	RO
PDO Mapping	No
Value Range	4
Default Value	4

Sub-Index	1h to 4h (Y = 1 to 4)
Description	Math Y Enable
Access	RW
PDO Mapping	No
Value Range	0 (FALSE) or 1 (TRUE)
Default Value	0 [FALSE]

3.5.25. Object 4021h: Math Output Scaling 1 PV

This object defines the process value that would correspond to 0% output from the math calculation. The object would apply the resolution defined in object 4532h Math Output Decimal Digits PV. The physical unit is undefined.

Object Description

Index	4021h
Name	Math Output Scaling 1 PV
Object Type	ARRAY
Data Type	INTEGER16

Entry Description

Sub-Index	0h
Description	Largest sub-index supported
Access	RO
PDO Mapping	No
Value Range	4
Default Value	4

Sub-Index	1h to 4h (Y = 1 to 4)
Description	Math Y Output Scaling 1 PV
Access	RW
PDO Mapping	No
Value Range	-32768 to 32767
Default Value	0

3.5.26. Object 4023h: Math Output Scaling 2 PV

This object defines the process value that would correspond to 100% output from the math calculation. The object would apply the resolution defined in object 4532h Math Output Decimal Digits PV. The physical unit is undefined.

Object Description

Index	4023h
Name	Math Output Scaling 2 PV
Object Type	ARRAY
Data Type	INTEGER16

Entry Description

Sub-Index	0h
Description	Largest sub-index supported
Access	RO
PDO Mapping	No
Value Range	4
Default Value	4

Sub-Index	1h to 4h (Y = 1 to 4)
Description	Math Y Output Scaling 2 PV
Access	RW
PDO Mapping	No

Value Range	-32768 to 32767
Default Value	10000 (100.00)

3.5.27. Object 4030h: Math Output PV

This read-only object reflects the output from the math function block after it has been scaled by objects 4021h and 4023h. The object would apply the resolution defined in object 4032h Math Output Decimal Digits PV. The physical unit is undefined.

Object Description

Index	4030h
Name	Math Output Process Value
Object Type	ARRAY
Data Type	INTEGER16

Entry Description

Sub-Index	0h
Description	Largest sub-index supported
Access	RO
PDO Mapping	No
Value Range	4
Default Value	4

Sub-Index	1h to 4h (Y = 1 to 4)
Description	Math Y Output Process Value
Access	RO
PDO Mapping	Yes
Value Range	-32768 to 32767
Default Value	No

3.5.28. Object 4032h: Math Output Decimal Digits PV

This object describes the number of digits following the decimal point (i.e. resolution) of the output data, which is interpreted with data type Integer16 in the process value object.

Object Description

Index	4032h
Name	Math Output Decimal Digits PV
Object Type	ARRAY
Data Type	UNSIGNED8

Entry Description

Sub-Index	0h
Description	Largest sub-index supported
Access	RO
PDO Mapping	No
Value Range	4
Default Value	4

Sub-Index	1h to 4h (Y = 1 to 4)
Description	Math Y Decimal Digits PV
Access	RW
PDO Mapping	No
Value Range	0 to 4
Default Value	2 (0.01)

3.5.29. Object 4y00h: Math Y Input Source

This object defines the input sources that will be used in the mathematical calculations. Here, y = 1 to 6 – representing Math Block 1 to Math Block 6. If a control source is not used, the associate mathematical calculation would be ignored.

Object Description

Index	4y00h (y = 1 to 6)
Name	Math Y Input Source
Object Type	ARRAY
Data Type	UNSIGNED8

Entry Description

Sub-Index	0h
Description	Largest sub-index supported
Access	RO
PDO Mapping	No
Value Range	4
Default Value	4

Sub-Index	1h to 4h (X = 1 to 4)
Description	Math Y Input X Source
Access	RW
PDO Mapping	No
Value Range	See Table 4
Default Value	0 (control source not used)

3.5.30. Object 4y01h: Math Y Input Number

This object defines the number of the input source that will be used in the math calculation. The available control numbers are dependent on the source selected, as shown in Table 5. Once selected, the input value will be used in the corresponding calculation as described in Section 1.7.

Object Description

Index	4y01h (y = 1 to 6)
Name	Math Y Input Number
Object Type	ARRAY
Data Type	UNSIGNED8

Entry Description

Sub-Index	0h
Description	Largest sub-index supported

Access	RO
PDO Mapping	No
Value Range	4
Default Value	4

Sub-Index	1h to 4h (X = 1 to 4)
Description	Math Y Input X Number
Access	RW
PDO Mapping	No
Value Range	See Table 6
Default Value	1

3.5.31. Object 4y02h: Math Y Input Function Number

This object defines the number of the function within the Math Block will be used in the math calculation. This object is applicable when the Input Source together with the Input Number match the Math Block that is being configured. If Input Source and Input Number match the Math Block being configured and the Function Number is 0, this object is ignored. For more details, refer to Section 1.11.

Object Description

Index	4y02h (y = 1 to 4)
Name	Math Y Input Function Number
Object Type	ARRAY
Data Type	UNSIGNED8

Entry Description

Sub-Index	0h
Description	Largest sub-index supported
Access	RO
PDO Mapping	No
Value Range	4
Default Value	4

Sub-Index	1h to 4h (X = 1 to 4)
Description	Math Y Input X Function Number
Access	RW
PDO Mapping	No
Value Range	0 to 3
Default Value	0

3.5.32. Object 4y03h: Math Y Input Decimal Digits FV

This object describes the number of digits following the decimal point (i.e. resolution) of the input data, which is interpreted with data type Integer16 in the field value object.

Object Description

Index	4y03h (y = 1 to 4)
Name	Math Y Input Decimal Digits FV
Object Type	ARRAY
Data Type	UNSIGNED8

Entry Description

Sub-Index	0h
Description	Largest sub-index supported
Access	RO
PDO Mapping	No
Value Range	4
Default Value	4

Sub-Index	1h to 6h (X = 1 to 4)
Description	Math Y Input X Decimal Digits PV
Access	RW
PDO Mapping	No
Value Range	0 to 4
Default Value	2 (0.01)

3.5.33. Object 4y20h: Math Y Input Scaling 1 FV

This object defines the input field value that would correspond to 0% when scaling the input for use in the math calculation. All inputs are normalized to a percentage before being used by the math function block. The object would apply the resolution defined in object 4y03h Math Y Input Decimal Digits FV. The physical unit would match that of the input source.

Object Description

Index	4y20h (y = 1 to 4)
Name	Math Y Input Scaling 1 FV
Object Type	ARRAY
Data Type	INTEGER16

Entry Description

Sub-Index	0h
Description	Largest sub-index supported
Access	RO
PDO Mapping	No
Value Range	4
Default Value	4

Sub-Index	1h to 4 (X = 1 to 4)
Description	Math Y Input X Scaling 1 FV
Access	RW
PDO Mapping	No
Value Range	INTEGER16
Default Value	0

3.5.34. Object 4y22h: Math Y Input Scaling 2 FV

This object defines the input field value that would correspond to 100% when scaling the input for use in the math calculation. All inputs are normalized to a percentage before being used by the math function block. The object would apply the resolution defined in object 4y03h Math Y Input Decimal Digits FV. The physical unit would match that of the input source.

Object Description

Index	4y22h (y = 1 to 4)
Name	Math Y Input Scaling 2 FV
Object Type	ARRAY
Data Type	INTEGER16

Entry Description

Sub-Index	0h
Description	Largest sub-index supported
Access	RO
PDO Mapping	No
Value Range	4
Default Value	4

Sub-Index	1h to 4h (X = 1 to 4)
Description	Math Y Input X Scaling 2 FV
Access	RW
PDO Mapping	No
Value Range	INTEGER16
Default Value	10000 (100.00%)

3.5.35. Object 4y40h: Math Y Input Gain

This object can be used to adjust the ‘weight’ of the input in the math calculation. It is a multiplier of the input after it has been converted into a percentage, before it is used in the math calculation. This object has a fixed resolution of 2 decimal digits.

Object Description

Index	4y40h (y = 1 to 4)
Name	Math Y Input Gain
Object Type	ARRAY
Data Type	INTEGER8

Entry Description

Sub-Index	0h
Description	Largest sub-index supported
Access	RO
PDO Mapping	No
Value Range	4
Default Value	4

Sub-Index	1h to 4h (X = 1 to 4)
Description	Math Y Input X Gain

Access	RW
PDO Mapping	No
Value Range	-100 to 100
Default Value	100 (1.0)

3.5.36. Object 4y50h: Math Y Operator

This object defines the actual operators that will be used in each stage of a math calculation. The options for this object are listed in **Error! Reference source not found.**

Object Description

Index	4y50h (y = 1 to 4)
Name	Math Y Operator
Object Type	ARRAY
Data Type	UNSIGNED8

Entry Description

Sub-Index	0h
Description	Largest sub-index supported
Access	RO
PDO Mapping	No
Value Range	3
Default Value	3

Sub-Index	1h to 3h (X = 1 to 3)
Description	Math Y Function X Operator
Access	RW
PDO Mapping	No
Value Range	See Table 19
Default Value	12 (Plus)

3.5.37. Object 4500h: COND LOGIC Enabled

This object enables the use of each Conditional Logic Block.

Object Description

Index	4500h
Name	COND LOGIC Enabled
Object Type	ARRAY
Data Type	UNSIGNED8

Entry Description

Sub-Index	0h
Description	Largest sub-index supported
Access	RO
PDO Mapping	No
Value Range	10
Default Value	10

Sub-Index	1h to Ah (x = 1 to 10)
Description	COND LOGIC x Enabled
Access	RW
PDO Mapping	No
Value Range	0 to 1
Default Value	0

3.5.38. Object 4501h: COND LOGIC Output PV

This read-only object reflects the output Processed Value from the Conditional Logic Block.

Object Description

Index	4501h
Name	COND LOGIC Output PV
Object Type	ARRAY
Data Type	UNSIGNED8

Entry Description

Sub-Index	0h
Description	Largest sub-index supported
Access	RO
PDO Mapping	No
Value Range	10
Default Value	10

Sub-Index	1h to Ah (x = 1 to 10)
Description	COND LOGIC x Enabled
Access	RO
PDO Mapping	Yes
Value Range	0 to 1
Default Value	0

3.5.39. Object 4y10h: COND LOGIC (y-4) Result Operator

This object defines the Result Operator for each condition of the associated Conditional Logic Block.

Object Description

Index	4y10h (y = 5 to E)
Name	COND LOGIC Output PV
Object Type	ARRAY
Data Type	UNSIGNED8

Entry Description

Sub-Index	0h
Description	Largest sub-index supported
Access	RO
PDO Mapping	No
Value Range	10

Default Value	10
---------------	----

Sub-Index	1h to 2h (x = 1 to 2)
Description	COND LOGIC y Condition x Result Operator
Access	RW
PDO Mapping	No
Value Range	0 to 4
Default Value	1

3.5.40. Object 4y20h: COND LOGIC (y-4) Condition 1

3.5.41. Object 4y25h: COND LOGIC (y-4) Condition 2

These objects define the conditions for each Conditional Logic Block. All of these objects are a special type of record.

Object Description

Index	4y2zh (y = 5 to E, z = 0 or 5)
Name	COND LOGIC (y-4) Condition
Object Type	RECORD
Data Type	UNSIGNED8

Entry Description

Sub-Index	0h
Description	Largest sub-index supported
Access	RO
PDO Mapping	No
Value Range	5
Default Value	5

Sub-Index	1h
Description	Argument 1 Source
Access	RW
PDO Mapping	No
Value Range	0 to 11
Default Value	0

Sub-Index	2h
Description	Argument 1 Number
Access	RW
PDO Mapping	No
Value Range	See Table 6
Default Value	1

Sub-Index	3h
Description	Argument 2 Source
Access	RW
PDO Mapping	No
Value Range	0 to 11

Default Value	0
---------------	---

Sub-Index	4h
Description	Argument 2 Number
Access	RW
PDO Mapping	No
Value Range	See Table 6
Default Value	1

Sub-Index	5h
Description	Operator
Access	RW
PDO Mapping	No
Value Range	0 to 5
Default Value	0 (Equals)

3.5.42. Object 4Fy0h: SRL (y+1) Enabled

This object enables the associated Set-Reset Latch.

Object Description

Index	4Fy0h (y = 0 to 2)
Name	SRL (y+1) Enabled
Object Type	VAR
Data Type	UNSIGNED8
Access	RW
PDO Mapping	No
Value Range	0 to 1
Default Value	0

3.5.43. Object 4Fy1h: SRL (y+1) Set Control Source

This object defines the Set Control Source for a SR Latch.

Object Description

Index	4Fy1h (y = 0 to 2)
Name	SRL (y+1) Set Control Source
Object Type	VAR
Data Type	UNSIGNED8
Access	RW
PDO Mapping	No
Value Range	0 to 11
Default Value	0

3.5.44. Object 4Fy2h: SRL (y+1) Set Control Number

This object defines the Set Control Number for a SR Latch.

Object Description

Index	4Fy2h (y = 0 to 2)
Name	SRL (y+1) Set Control Number
Object Type	VAR
Data Type	UNSIGNED8
Access	RW
PDO Mapping	No
Value Range	See Table 6
Default Value	1

3.5.45. Object 4Fy3h: SRL (y+1) Reset Control Source

This object defines the Reset Control Source for a SR Latch.

Object Description

Index	4Fy3h (y = 0 to 2)
Name	SRL (y+1) Reset Control Source
Object Type	VAR
Data Type	UNSIGNED8
Access	RW
PDO Mapping	No
Value Range	0 to 11
Default Value	0

3.5.46. Object 4Fy4h: SRL (y+1) Reset Control Number

This object defines the Reset Control Number for a SR Latch.

Object Description

Index	4Fy4h (y = 0 to 2)
Name	SRL (y+1) Reset Control Number
Object Type	VAR
Data Type	UNSIGNED8
Access	RW
PDO Mapping	No
Value Range	See Table 6
Default Value	1

3.5.47. Object 4Fy5h: SRL (y+1) Set Input On Percent

This object defines the On Percentage Threshold for Set Control for a SR Latch.

Object Description

Index	4Fy5h (y = 0 to 2)
Name	SRL (y+1) Set Input On Percent
Object Type	VAR
Data Type	UNSIGNED16
Access	RW
PDO Mapping	No
Value Range	0 to 100

Default Value	0
---------------	---

3.5.48. Object 4Fy6h: SRL (y+1) Reset Input On Percent

This object defines the On Percentage Threshold for Reset Control for a SR Latch.

Object Description

Index	4Fy6h (y = 0 to 2)
Name	SRL (y+1) Reset Input On Percent
Object Type	VAR
Data Type	UNSIGNED16
Access	RW
PDO Mapping	No
Value Range	0 to 100
Default Value	0

3.5.49. Object 4Fy7h: SRL (y+1) Set Input Off Percent

This object defines the Off Percentage Threshold for Set Control for a SR Latch.

Object Description

Index	4Fy7h (y = 0 to 2)
Name	SRL (y+1) Set Input Off Percent
Object Type	VAR
Data Type	UNSIGNED16
Access	RW
PDO Mapping	No
Value Range	0 to 100
Default Value	0

3.5.50. Object 4Fy8h: SRL (y+1) Reset Input Off Percent

This object defines the Off Percentage Threshold for Reset Control for a SR Latch.

Object Description

Index	4Fy8h (y = 0 to 2)
Name	SRL (y+1) Reset Input Off Percent
Object Type	VAR
Data Type	UNSIGNED16
Access	RW
PDO Mapping	No
Value Range	0 to 100
Default Value	0

3.5.51. Object 4Fy9h: SRL (y+1) Output PV

This read-only object defines the Output Processed Value for the SR Latch.

Object Description

Index	4Fy9h (y = 0 to 2)
Name	SRL (y+1) Output PV
Object Type	VAR
Data Type	UNSIGNED8
Access	RO
PDO Mapping	Yes
Value Range	0 to 1
Default Value	0

4. Technical Specifications

Specifications are indicative and subject to change. Actual performance will vary depending on the application and operating conditions. Users should satisfy themselves that the product is suitable for use in the intended application. All our products carry a limited warranty against defects in material and workmanship. Please refer to our Warranty, Application Approvals/Limitations and Return Materials Process as described on <https://www.axiomatic.com/service/>.

4.1. Power Supply

Power Supply Input - Nominal	12 or 24Vdc nominal operating voltage 8...36 Vdc power supply range for voltage transients
Surge Protection	Provided
Reverse Polarity Protection	Provided

4.2. Inputs

Strain Gauge Inputs	4 Channels Accepts 4-wire Strain Gauge inputs Input range selectable from +/- 19.5 mV to +/- 2.5 Vdc. All input channels have excitation and ground connections provided. All inputs may send a message to the CAN bus.
Measurement rate	The measurement rate is 2.5 scans per second for all 4 channels. The update rate is 400 mSec. for all 4 channels.
Common mode	Common-mode rejection is > 100 db.@ 1V p-p, simultaneous 50/60 Hz. Common mode input range is +/- 3.5V maximum.
Resolution	18.2-Bit noise-free minimum
Drift	Overall drift with temperature is 50 ppm/°C of span (maximum).
Input Accuracy	+/- 0.5% throughout the entire range of the input
Excitation	4 +5V excitation connections
Other Input	1 Digital Input Active High to 5V or Active Low to GND Configurable Pull Up or Pull Down Resistor Amplitude: up to +Vps
Grounds	4 GND connections

4.3. Output

Analog/Digital Output	1 Analog/Digital Output Analog Output has selectable range of 0 to 10V and 0 to 24mA Digital Output On/Off Fully protected high side digital switch with low current readings 2A Overcurrent, overvoltage and undervoltage protection is provided.
Relay Output	An interlock relay with 2 contact pins is provided. 2A (nominal)

4.4. Communication

CAN	1 CAN 2.0B port, protocol SAE J1939
Network Termination	According to the CAN standard, it is necessary to terminate the network with external termination resistors. The resistors are 120 Ohm, 0.25W minimum, metal film or similar type. They should be placed between CAN_H and CAN_L terminals at both ends of the network.

4.5. General Specifications

Microprocessor	STM32F407VGT7
Communications	1 CAN port Model: AX200300 - SAE J1939 - Baud rate: 250, 500, 667 kbit/s, 1 Mbit/s. Automatic baud rate detection. Model: AX200301 - CANopen® - Baud Rate: 10, 20, 50, 100, 125, 250, 500, 800, 1000 kbit/s. Adjustable through firmware.
User Interface	The Axiomatic Electronic Assistant, P/Ns: AX070502 or AX070506K
Wire Break Detection	Included
Control Logic	Standard embedded control logic is provided. Application-specific control logic is available on request.
SAE J1939 Compliance	The ECU is compliant with the following SAE J1939 standards:

	<ul style="list-style-type: none"> • J1939 Recommended Practice for a Serial Control and Communications Vehicle Network, SAE, April 2011 • J1939/21 Data Link Layer, SAE, December 2010 • J1939/71 Vehicle Application Layer, SAE, March 2011 • J1939/81 Network Management, SAE, May 2003
--	--

Electrical Connections	<p>24-pin receptacle – (equivalent TE Deutsch P/N: DTM13-12PA-12PB-R008) Mating plug: TE Deutsch DTM06-12SA and DTM06-12SB with 2 wedgelocks (WM12S) and 24 contacts (0462-201-20141). 20 AWG wire is recommended for use with contacts 0462-201-20141.</p> <table border="1"> <thead> <tr> <th colspan="2">Grey Connector</th> <th colspan="2">Black Connector</th> </tr> <tr> <th>Pin #</th> <th>Function</th> <th>Pin #</th> <th>Function</th> </tr> </thead> <tbody> <tr> <td>1</td> <td>+5V Excitation 1</td> <td>1</td> <td>GND 3</td> </tr> <tr> <td>2</td> <td>V IN 1+</td> <td>2</td> <td>V IN 3-</td> </tr> <tr> <td>3</td> <td>+5V Excitation 2</td> <td>3</td> <td>GND 4</td> </tr> <tr> <td>4</td> <td>V IN 2+</td> <td>4</td> <td>V IN 4-</td> </tr> <tr> <td>5</td> <td>Tare Input</td> <td>5</td> <td>Interlock +/-</td> </tr> <tr> <td>6</td> <td>BATT-</td> <td>6</td> <td>CAN_H</td> </tr> <tr> <td>7</td> <td>BATT+</td> <td>7</td> <td>CAN_L</td> </tr> <tr> <td>8</td> <td>Digital Output</td> <td>8</td> <td>Interlock +/-</td> </tr> <tr> <td>9</td> <td>V IN 2 -</td> <td>9</td> <td>V IN 4+</td> </tr> <tr> <td>10</td> <td>GND 2</td> <td>10</td> <td>+5V Excitation 4</td> </tr> <tr> <td>11</td> <td>V IN 1 -</td> <td>11</td> <td>V IN 3+</td> </tr> <tr> <td>12</td> <td>GND 1</td> <td>12</td> <td>+5V Excitation 3</td> </tr> </tbody> </table>	Grey Connector		Black Connector		Pin #	Function	Pin #	Function	1	+5V Excitation 1	1	GND 3	2	V IN 1+	2	V IN 3-	3	+5V Excitation 2	3	GND 4	4	V IN 2+	4	V IN 4-	5	Tare Input	5	Interlock +/-	6	BATT-	6	CAN_H	7	BATT+	7	CAN_L	8	Digital Output	8	Interlock +/-	9	V IN 2 -	9	V IN 4+	10	GND 2	10	+5V Excitation 4	11	V IN 1 -	11	V IN 3+	12	GND 1	12	+5V Excitation 3
Grey Connector		Black Connector																																																							
Pin #	Function	Pin #	Function																																																						
1	+5V Excitation 1	1	GND 3																																																						
2	V IN 1+	2	V IN 3-																																																						
3	+5V Excitation 2	3	GND 4																																																						
4	V IN 2+	4	V IN 4-																																																						
5	Tare Input	5	Interlock +/-																																																						
6	BATT-	6	CAN_H																																																						
7	BATT+	7	CAN_L																																																						
8	Digital Output	8	Interlock +/-																																																						
9	V IN 2 -	9	V IN 4+																																																						
10	GND 2	10	+5V Excitation 4																																																						
11	V IN 1 -	11	V IN 3+																																																						
12	GND 1	12	+5V Excitation 3																																																						
Packaging and Dimensions	High Temperature Nylon PCB Enclosure - (equivalent TE Deutsch P/N: EEC-325X4B) 4.68 x 5.25 x 1.42 inches 119 x 133 x 36 mm (W x L x H excluding mating plugs)																																																								
Operating Conditions	-40 to 85°C (-40 to 185°F)																																																								
Weight	0.50 lb. (0.23 kg)																																																								
Protection	IP67, PCB assembly is conformal coated.																																																								
Vibration	MIL-STD-202G, Test 204D and 214A (Sine and Random) 10 g peak (Sine) 7.86 Grms peak (Random)																																																								
Shock	MIL-STD-202G, Test 213B 50g																																																								
Mounting	Mounting holes sized for ¼ inch or M6 bolts. The bolt length will be determined by the end-user's mounting plate thickness. The mounting flange of the controller is 0.63 inches (16 mm) thick. All field wiring should be suitable for the operating temperature range. Install the unit with appropriate space available for servicing and for adequate wire harness access (6 inches or 15 cm) and strain relief (12 inches or 30 cm).																																																								

5. VERSION HISTORY

Version	Date	Author	Modifications
1	October 6 th , 2021	Peter Sotirakos	Initial Draft; Modified from UMAX200300 V1.0
1.01	July 31 st , 2023	Kiril Mojsov	Legacy Updates

OUR PRODUCTS

AC/DC Power Supplies
Actuator Controls/Interfaces
Automotive Ethernet Interfaces
Battery Chargers
CAN Controls, Routers, Repeaters
CAN/WiFi, CAN/Bluetooth, Routers
Current/Voltage/PWM Converters
DC/DC Power Converters
Engine Temperature Scanners
Ethernet/CAN Converters,
Gateways, Switches
Fan Drive Controllers
Gateways, CAN/Modbus, RS-232
Gyroscopes, Inclinometers
Hydraulic Valve Controllers
Inclinometers, Triaxial
I/O Controls
LVDT Signal Converters
Machine Controls
Modbus, RS-422, RS-485 Controls
Motor Controls, Inverters
Power Supplies, DC/DC, AC/DC
PWM Signal Converters/Isolators
Resolver Signal Conditioners
Service Tools
Signal Conditioners, Converters
Strain Gauge CAN Controls
Surge Suppressors

OUR COMPANY

Axiomatic provides electronic machine control components to the off-highway, commercial vehicle, electric vehicle, power generator set, material handling, renewable energy and industrial OEM markets. ***We innovate with engineered and off-the-shelf machine controls that add value for our customers.***

QUALITY DESIGN AND MANUFACTURING

We have an ISO9001:2015 registered design/manufacturing facility in Canada.

WARRANTY, APPLICATION APPROVALS/LIMITATIONS

Axiomatic Technologies Corporation reserves the right to make corrections, modifications, enhancements, improvements, and other changes to its products and services at any time and to discontinue any product or service without notice. Customers should obtain the latest relevant information before placing orders and should verify that such information is current and complete. Users should satisfy themselves that the product is suitable for use in the intended application. All our products carry a limited warranty against defects in material and workmanship. Please refer to our Warranty, Application Approvals/Limitations and Return Materials Process at <https://www.axiomatic.com/service/>.

COMPLIANCE

Product compliance details can be found in the product literature and/or on axiomatic.com. Any inquiries should be sent to sales@axiomatic.com.

SAFE USE

All products should be serviced by Axiomatic. Do not open the product and perform the service yourself.



This product can expose you to chemicals which are known in the State of California, USA to cause cancer and reproductive harm. For more information go to www.P65Warnings.ca.gov.

SERVICE

All products to be returned to Axiomatic require a Return Materials Authorization Number (RMA#) from sales@axiomatic.com. Please provide the following information when requesting an RMA number:

- Serial number, part number
- Runtime hours, description of problem
- Wiring set up diagram, application and other comments as needed

DISPOSAL

Axiomatic products are electronic waste. Please follow your local environmental waste and recycling laws, regulations and policies for safe disposal or recycling of electronic waste.

CONTACTS

Axiomatic Technologies Corporation
1445 Courtneypark Drive E.
Mississauga, ON
CANADA L5T 2E3
TEL: +1 905 602 9270
FAX: +1 905 602 9279
www.axiomatic.com
sales@axiomatic.com

Axiomatic Technologies Oy
Höytämöntie 6
33880 Lempäälä
FINLAND
TEL: +358 103 375 750
www.axiomatic.com
salesfinland@axiomatic.com